

Aroid
CONTRACT • CONTRAT
A GROUPE LACASSE BRAND



Price List
Effective January 2015

Table of Contents

| | |
|--|-------|
| About Arold / How to Use this Price List / What about special products? | 3 |
| Seating collections | 4-52 |
| Accessories | 53 |
| C.O.M./C.O.V. Policy | 54 |
| Custom Fabric Form | 55 |
| Terms and Conditions | 56-57 |
| Warranty | 58 |
| Lacasse thermofused laminate finishes / Arold wood finishes / Sample Order | 59 |

Quick Reference Index

| Series | Series Abbrev. | Modular | Lounge | Public Areas | Healthcare | Page |
|----------------|----------------|---------|--------|--------------|------------|-------|
| Aerial | AE | | | • | • | 4-5 |
| Apéro | AP | | • | | | 6 |
| Barolo | BA | | • | | | 7 |
| Bourbon | BB | | • | | | 8 |
| Churchill | CH | | • | | | 9 |
| Cube 100 | CU1 | | • | • | | 10-11 |
| Cube 200 | CU2 | • | • | • | | 12-15 |
| Cube 300 | CU3 | • | • | • | | 16-19 |
| Florence | FL | | • | | | 20 |
| Hip Hop | H | • | • | • | | 21-34 |
| Hip Hop Junior | HJ | • | • | • | | 34-36 |
| Lincoln | LC | | • | | | 37 |
| Martini | MA | | • | | | 38 |
| Napa | NA | | • | | | 39 |
| Oly | LY | | • | | | 40 |
| Pouf | PF | | • | | | 41-42 |
| Soho | SH | | • | | | 43 |
| Sonoma | SO | | • | | | 44 |
| Terra | TE | | | • | • | 45-48 |
| Zeta | ZE | | | • | | 49-52 |

Important note: Any artistic, photographic, clerical, typographical and pricing errors and omissions in this price list are subject to correction. Prices and product specifications are subject to change without notice.

www.groupelacasse.com

ABOUT AROLD...

Arold is synonym of quality, craftsmanship and endless possibilities.

Great expertise and experience have been put together to develop products that will fit your needs and ignite the designer in you. No matter the space you are creating, may it be large or small, for public areas or healthcare facilities, Arold has the product you need.

We look forward to assist you with any questions and support your efforts to make Arold a prized brand under our already successful family of products.

Take a seat and feel the Arold difference.

WHAT ABOUT SPECIAL PRODUCTS?

Groupe Lacasse stands out for its unwavering commitment to flexibility and Arold is no exception. We can help you with non-standard seating solutions to your specific environment, your special needs and your budget. Please contact **Groupe Lacasse Quotations Department** for an assessment of your request.

HOW TO USE THIS PRICE LIST

Find the products you need

Refer to the **Table of Contents** to find the solutions you require.

Pictures of various models are available on the Groupe Lacasse website (www.groupelacasse.com).

Specify the upholstery and finishes you want

Once you've selected the products that meet your needs, refer to the appropriate upholstery and finish document that can be found in the login section of the website and make a note of the applicable codes.

Refer to the **Sample Order** sections specific to each model to ensure integrity of order.

Submit your order

Fax: Groupe Lacasse Inc.
Attn: Order Entry
1-800-363-5474

Email: oecc@groupelacasse.com

Contact us if you have questions

Making sure you get what you need – on time and accurately – is our first priority. Should you ever have questions, please feel free to contact our Customer Service department.

Telephone: 1-888-522-2773
Email: customerservice@groupelacasse.com



HEALTHCARE AND PUBLIC AREAS

SPECIFICATIONS

- All models ship assembled.
- Fabric/fabric, fabric/vinyl and vinyl/vinyl dual upholstery is available. The first upholstery code is the backrest and a seat cushion, the second upholstery code is for the arms and outer back. As for the 3-seat ottoman, the first upholstery code is for the ottomans at the extremities, the second upholstery code is for the middle ottoman.
- If dual upholstery combination is from two different grades, list price is the highest grade of the two.
- 1 ½" gap around seat cushion for ease of cleaning.
- 16-gauge steel base and belt.
- Levelers allow up to 1" height adjustment.
- Please refer to accessories on page 53 for ganging brackets and floor anchors.
- C.O.M./C.O.V.: please refer to page 54.

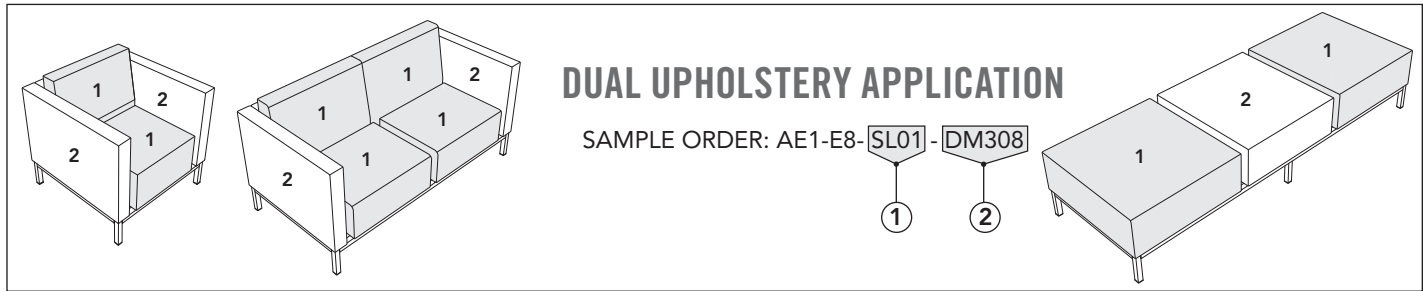

SAMPLE ORDER: AE1-E8-SL01-DM308

AE1

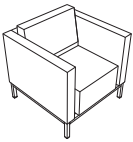

| Description | Dimensions | (in) | (mm) | Dimensions | (in) | (mm) |
|-------------|-------------|------|------|----------------|------|------|
| Armchair | Seat width | 23 ½ | 597 | Overall width | 30 ½ | 775 |
| | Seat depth | 21 | 533 | Overall depth | 30 ½ | 775 |
| | Seat height | 18 | 457 | Overall height | 31 | 787 |
| | Back height | 13 ½ | 343 | | | |

| Model | Frame | Upholstery / List (\$) |
|-------|--------|------------------------|
| AE1 | E8 Std | Grade 1 1,564 |
| | | Grade 2 1,589 |
| | E9 N/C | Grade 3 1,620 |
| | | Grade 4 1,651 |
| | | Grade 5 1,682 |
| | | Grade 6 1,714 |
| | | Grade 7 2,716 |
| | | Grade 8 1,776 |

AE2

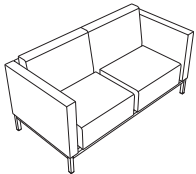

| Description | Dimensions | (in) | (mm) | Dimensions | (in) | (mm) |
|-------------|-------------|------|------|----------------|------|------|
| Loveseat | Seat width | 54 | 1372 | Overall width | 61 | 1549 |
| | Seat depth | 21 | 533 | Overall depth | 30 ½ | 775 |
| | Seat height | 18 | 457 | Overall height | 31 | 787 |
| | Back height | 13 ½ | 343 | | | |

| Model | Frame | Upholstery / List (\$) |
|-------|--------|------------------------|
| AE2 | E8 Std | Grade 1 2,595 |
| | | Grade 2 2,638 |
| | E9 N/C | Grade 3 2,692 |
| | | Grade 4 2,746 |
| | | Grade 5 2,800 |
| | | Grade 6 2,854 |
| | | Grade 7 4,571 |
| | | Grade 8 2,961 |

AE3

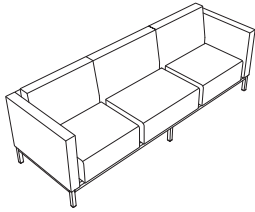

| Description | Dimensions | (in) | (mm) | Dimensions | (in) | (mm) |
|-------------|-------------|------|------|----------------|------|------|
| Sofa | Seat width | 84 ½ | 2146 | Overall width | 91 ½ | 2324 |
| | Seat depth | 21 | 533 | Overall depth | 30 ½ | 775 |
| | Seat height | 18 | 457 | Overall height | 31 | 787 |
| | Back height | 13 ½ | 343 | | | |

| Model | Frame | Upholstery / List (\$) | |
|-------|--------|------------------------|-------|
| AE3 | E8 Std | Grade 1 | 3,596 |
| | | Grade 2 | 3,658 |
| | E9 N/C | Grade 3 | 3,735 |
| | | Grade 4 | 3,811 |
| | | Grade 5 | 3,888 |
| | | Grade 6 | 3,965 |
| | | Grade 7 | 6,428 |
| | | Grade 8 | 4,119 |

AE01

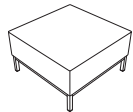

| Description | Dimensions | (in) | (mm) |
|----------------|----------------|------|------|
| 1-seat ottoman | Overall width | 30 ½ | 775 |
| | Overall depth | 30 ½ | 775 |
| | Overall height | 18 | 457 |

| Model | Frame | Upholstery / List (\$) | |
|-------|--------|------------------------|-------|
| AE01 | E8 Std | Grade 1 | 951 |
| | | Grade 2 | 961 |
| | E9 N/C | Grade 3 | 973 |
| | | Grade 4 | 986 |
| | | Grade 5 | 998 |
| | | Grade 6 | 1,011 |
| | | Grade 7 | 1,499 |
| | | Grade 8 | 1,036 |

AE02

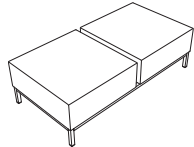

| Description | Dimensions | (in) | (mm) |
|----------------|----------------|------|------|
| 2-seat ottoman | Overall width | 61 | 1549 |
| | Overall depth | 30 ½ | 775 |
| | Overall height | 18 | 457 |

| Model | Frame | Upholstery / List (\$) | |
|-------|--------|------------------------|-------|
| AE02 | E8 Std | Grade 1 | 1,676 |
| | | Grade 2 | 1,696 |
| | E9 N/C | Grade 3 | 1,721 |
| | | Grade 4 | 1,746 |
| | | Grade 5 | 1,771 |
| | | Grade 6 | 1,796 |
| | | Grade 7 | 2,774 |
| | | Grade 8 | 1,846 |

AE03

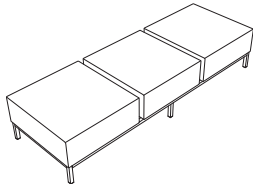

| Description | Dimensions | (in) | (mm) |
|----------------|----------------|------|------|
| 3-seat ottoman | Overall width | 91 ½ | 2324 |
| | Overall depth | 30 ½ | 775 |
| | Overall height | 18 | 457 |

| Model | Frame | Upholstery / List (\$) | |
|-------|--------|------------------------|-------|
| AE03 | E8 Std | Grade 1 | 2,283 |
| | | Grade 2 | 2,313 |
| | E9 N/C | Grade 3 | 2,350 |
| | | Grade 4 | 2,388 |
| | | Grade 5 | 2,425 |
| | | Grade 6 | 2,463 |
| | | Grade 7 | 3,929 |
| | | Grade 8 | 2,538 |

LOUNGE

SPECIFICATIONS

- All models ship assembled.
- Fabric/fabric, fabric/vinyl and vinyl/vinyl dual upholstery is available. The first upholstery code is the backrest and arms, the second upholstery code is for the seat.
- If dual upholstery combination is from two different grades, list price is the highest grade of the two.
- 4 ½" height metal legs in aluminum finish.
- C.O.M./C.O.V.: please refer to page 54.

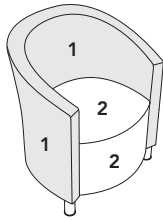

DUAL UPHOLSTERY APPLICATION

SAMPLE ORDER: AP1-ML-SL01-DM308



SAMPLE ORDER: AP1-ML-SL01-DM308

AP1

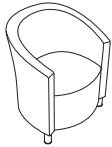

| Description | Dimensions | (in) | (mm) | Dimensions | (in) | (mm) |
|---------------|-------------|------|------|----------------|------|------|
| Armchair | Seat width | 21 ½ | 546 | Overall width | 28 | 711 |
| Aluminum legs | Seat depth | 20 | 508 | Overall depth | 26 ½ | 673 |
| | Seat height | 18 ½ | 470 | Overall height | 32 | 813 |
| | Back height | 13 ½ | 343 | | | |

| Model | Frame | Upholstery / List (\$) |
|-------|--------|------------------------|
| AP1 | ML Std | Grade 1 1,520 |
| | | Grade 2 1,540 |
| | | Grade 3 1,565 |
| | | Grade 4 1,590 |
| | | Grade 5 1,615 |
| | | Grade 6 1,640 |
| | | Grade 7 2,178 |
| | | Grade 8 1,690 |

AP1SB



| Description | Dimensions | (in) | (mm) | Dimensions | (in) | (mm) |
|---------------|-------------|------|------|----------------|------|------|
| Chair | Seat width | 21 ½ | 546 | Overall width | 24 | 610 |
| Aluminum legs | Seat depth | 20 | 508 | Overall depth | 26 ½ | 673 |
| | Seat height | 18 ½ | 470 | Overall height | 32 | 813 |
| | Back height | 13 ½ | 343 | | | |

| Model | Frame | Upholstery / List (\$) |
|-------|--------|------------------------|
| AP1SB | ML Std | Grade 1 1,245 |
| | | Grade 2 1,262 |
| | | Grade 3 1,284 |
| | | Grade 4 1,306 |
| | | Grade 5 1,328 |
| | | Grade 6 1,350 |
| | | Grade 7 1,738 |
| | | Grade 8 1,393 |

LOUNGE

SPECIFICATIONS

- Ships assembled.
- Fabric/fabric, fabric/vinyl and vinyl/vinyl dual upholstery is available. The first upholstery code is the backrest and arms, the second upholstery code is for the seat.
- If dual upholstery combination is from two different grades, list price is the highest grade of the two.
- C.O.M./C.O.V.: please refer to page 54.

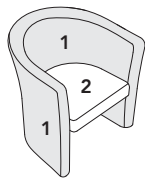

DUAL UPHOLSTERY APPLICATION

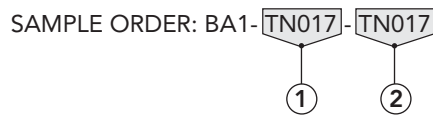

SAMPLE ORDER: BA1-TN017-TN017

BA1

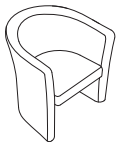

| Description | Dimensions | (in) | (mm) | Dimensions | (in) | (mm) |
|---------------------------|-------------|------|------|----------------|------|------|
| Armchair | Seat width | 19 ½ | 495 | Overall width | 30 ½ | 775 |
| Integrated lumbar support | Seat depth | 19 ½ | 495 | Overall depth | 31 | 788 |
| | Seat height | 17 ½ | 445 | Overall height | 31 ¾ | 807 |
| | Back height | 14 ¼ | 362 | | | |

| Model | Upholstery / List (\$) |
|-------|------------------------|
| BA1 | Grade 1 1,357 |
| | Grade 2 1,377 |
| | Grade 3 1,402 |
| | Grade 4 1,427 |
| | Grade 5 1,452 |
| | Grade 6 1,477 |
| | Grade 7 2,279 |
| | Grade 8 1,527 |

LOUNGE

SPECIFICATIONS

- All models ship assembled.
- Available in one tone only.

- C.O.M./C.O.V.: please refer to page 54.

SAMPLE ORDER: BB2-ML-OL04

BB1

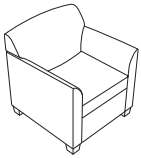

| Description | Dimensions | (in) | (mm) | Dimensions | (in) | (mm) |
|---------------|-------------|------|------|----------------|------|------|
| Armchair | Seat width | 21 | 533 | Overall width | 29 ½ | 749 |
| Aluminum legs | Seat depth | 21 ½ | 546 | Overall depth | 32 ½ | 826 |
| | Seat height | 17 ¼ | 438 | Overall height | 33 ¼ | 845 |
| | Back height | 16 | 432 | | | |

| Model | Frame | Upholstery / List (\$) |
|-------|--------|------------------------|
| BB1 | ML Std | Grade 1 1,864 |
| | | Grade 2 1,894 |
| | | Grade 3 1,931 |
| | | Grade 4 1,969 |
| | | Grade 5 2,006 |
| | | Grade 6 2,044 |
| | | Grade 7 3,104 |
| | | Grade 8 2,119 |

BB2

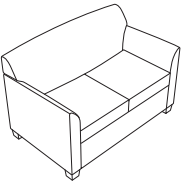

| Description | Dimensions | (in) | (mm) | Dimensions | (in) | (mm) |
|---------------|-------------|------|------|----------------|------|------|
| Loveseat | Seat width | 43 | 1092 | Overall width | 51 | 1295 |
| Aluminum legs | Seat depth | 21 ½ | 546 | Overall depth | 32 ½ | 826 |
| | Seat height | 17 ¼ | 438 | Overall height | 33 ¼ | 845 |
| | Back height | 16 | 432 | | | |

| Model | Frame | Upholstery / List (\$) |
|-------|--------|------------------------|
| BB2 | ML Std | Grade 1 2,427 |
| | | Grade 2 2,464 |
| | | Grade 3 2,511 |
| | | Grade 4 2,558 |
| | | Grade 5 2,605 |
| | | Grade 6 2,652 |
| | | Grade 7 3,985 |
| | | Grade 8 2,746 |

BB3

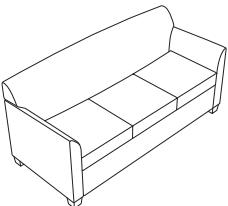

| Description | Dimensions | (in) | (mm) | Dimensions | (in) | (mm) |
|---------------|-------------|------|------|----------------|------|------|
| Sofa | Seat width | 64 ½ | 1638 | Overall width | 72 ½ | 1842 |
| Aluminum legs | Seat depth | 21 ½ | 546 | Overall depth | 32 ½ | 826 |
| | Seat height | 17 ¼ | 438 | Overall height | 33 ¼ | 845 |
| | Back height | 16 | 432 | | | |

| Model | Frame | Upholstery / List (\$) |
|-------|--------|------------------------|
| BB3 | ML Std | Grade 1 2,921 |
| | | Grade 2 2,976 |
| | | Grade 3 3,044 |
| | | Grade 4 3,113 |
| | | Grade 5 3,182 |
| | | Grade 6 3,251 |
| | | Grade 7 5,204 |
| | | Grade 8 3,388 |

LOUNGE

SPECIFICATIONS

- All models ship assembled.
- Available in one tone only.
- Refer to page 59 for the 4 wood leg finishes available.
- C.O.M./C.O.V.: please refer to page 54.

SAMPLE ORDER: CH3-W1-CY07

CH1



| Description | Dimensions | (in) | (mm) | Dimensions | (in) | (mm) |
|-------------------------|-------------|------|------|----------------|------|------|
| Armchair Wooden legs | Seat width | 21 | 533 | Overall width | 35 | 889 |
| | Seat depth | 21 | 533 | Overall depth | 33 | 832 |
| | Seat height | 17 | 432 | Overall height | 34 | 864 |
| | Back height | 17 | 432 | | | |

| Model | Frame | Upholstery / List (\$) | |
|-------|--------|------------------------|-------|
| CH1 | W1 Std | Grade 1 | 1,907 |
| | | Grade 2 | 1,937 |
| | W2 N/C | Grade 3 | 1,975 |
| | | Grade 4 | 2,013 |
| | W3 N/C | Grade 5 | 2,050 |
| | | Grade 6 | 2,088 |
| | W4 N/C | Grade 7 | 3,148 |
| | | Grade 8 | 2,163 |

CH2

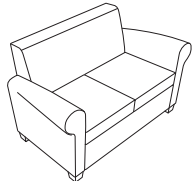

| Description | Dimensions | (in) | (mm) | Dimensions | (in) | (mm) |
|-------------------------|-------------|------|------|----------------|------|------|
| Loveseat Wooden legs | Seat width | 45 | 1143 | Overall width | 59 | 1449 |
| | Seat depth | 21 | 533 | Overall depth | 33 | 832 |
| | Seat height | 17 | 432 | Overall height | 34 | 864 |
| | Back height | 17 | 432 | | | |

| Model | Frame | Upholstery / List (\$) | |
|-------|--------|------------------------|-------|
| CH2 | W1 Std | Grade 1 | 2,495 |
| | | Grade 2 | 2,535 |
| | W2 N/C | Grade 3 | 2,585 |
| | | Grade 4 | 2,635 |
| | W3 N/C | Grade 5 | 2,685 |
| | | Grade 6 | 2,735 |
| | W4 N/C | Grade 7 | 4,153 |
| | | Grade 8 | 2,836 |

CH3

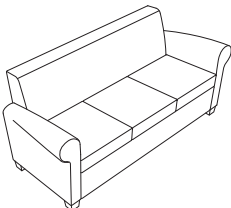

| Description | Dimensions | (in) | (mm) | Dimensions | (in) | (mm) |
|---------------------|-------------|------|------|----------------|------|------|
| Sofa Wooden legs | Seat width | 68 | 1727 | Overall width | 82 | 2083 |
| | Seat depth | 21 | 533 | Overall depth | 33 | 832 |
| | Seat height | 17 | 432 | Overall height | 34 | 864 |
| | Back height | 17 | 432 | | | |

| Model | Frame | Upholstery / List (\$) | |
|-------|--------|------------------------|-------|
| CH3 | W1 Std | Grade 1 | 2,996 |
| | | Grade 2 | 3,051 |
| | W2 N/C | Grade 3 | 3,119 |
| | | Grade 4 | 3,188 |
| | W3 N/C | Grade 5 | 3,257 |
| | | Grade 6 | 3,326 |
| | W4 N/C | Grade 7 | 5,279 |
| | | Grade 8 | 3,463 |

LOUNGE AND PUBLIC AREAS

SPECIFICATIONS

- All models ship assembled.
- Fabric/fabric, fabric/vinyl and vinyl/vinyl dual upholstery is available. The first upholstery code is the backrest and a seat cushion, the second upholstery code is for the arms and structure.
- If dual upholstery combination is from two different grades, list price is the highest grade of the two.
- Higher back optional feature adds 3" to the back cushion only.
- Tablet arm cannot be retrofitted on existing model.
- If optional electrical module is selected, the module will be located in left side of the front structure.
- 14-gauge steel belt with 16-gauge steel legs.
- 3" soft dual wheel casters are available on the armchair only.
- Levelers allow up to 1 ½" height adjustment.
- Please refer to your Lacasse Sampler for laminate choices.
- Please refer to accessories on page 53 for ganging brackets and floor anchors.
- C.O.M./C.O.V.: please refer to page 54.

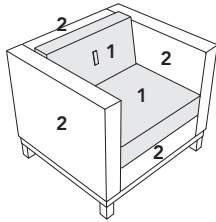

DUAL UPHOLSTERY APPLICATION

SAMPLE ORDER: CU110-E9-TN609-TN609-SA-TAL-TWT-DH



SAMPLE ORDER: CU110-E9-TN609-TN609-SA-TAL-TWT-DH

CU110

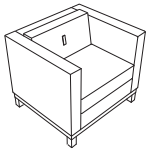

| Description | Dimensions | (in) | (mm) | Dimensions | (in) | (mm) |
|---------------------|-------------|------|------|----------------|------|------|
| Armchair | Seat width | 24 | 609 | Overall width | 32 ¾ | 832 |
| Metal base included | Seat depth | 18 ½ | 470 | Overall depth | 29 ½ | 750 |
| | Seat height | 17 ¼ | 438 | Overall height | 28 | 712 |
| | Back height | 10 ¾ | 273 | | | |

| Model | Frame | Upholstery / List (\$) | Button (\$) | Tablet arm (\$) | Tablet finis | Other options (\$) |
|-------|--------|------------------------|-------------|-----------------|-----------------------|--------------------|
| CU110 | E8 Std | Grade 1 1,526 | A Std | NA Std | NA Std | DH 50 |
| | E9 N/C | Grade 2 1,556 | SA N/C | TAL 407 | Specify laminate code | PC (1x) 600 |
| | | Grade 3 1,594 | | TAR 407 | | SDW 85 |
| | | Grade 4 1,631 | | | | CSB 50 |
| | | Grade 5 1,669 | | | | CSW 50 |
| | | Grade 6 1,706 | | | | |
| | | Grade 7 2,514 | | | | |
| | | Grade 8 1,781 | | | | |

CU120

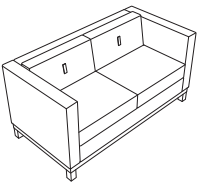

| Description | Dimensions | (in) | (mm) | Dimensions | (in) | (mm) |
|---------------------|-------------|------|------|----------------|------|------|
| Loveseat | Seat width | 48 | 1219 | Overall width | 56 ½ | 1535 |
| Metal base included | Seat depth | 18 ½ | 470 | Overall depth | 29 ½ | 750 |
| | Seat height | 17 ¼ | 438 | Overall height | 28 | 712 |
| | Back height | 10 ¾ | 273 | | | |

| Model | Frame | Upholstery / List (\$) | Button (\$) | Tablet arm (\$) | Tablet finis | Other options (\$) |
|-------|--------|------------------------|-------------|-----------------|-----------------------|--------------------|
| CU120 | E8 Std | Grade 1 2,301 | A Std | NA Std | NA Std | DH 100 |
| | E9 N/C | Grade 2 2,352 | SA N/C | TAL 407 | Specify laminate code | PC (1x) 600 |
| | | Grade 3 2,414 | | TAR 407 | | CSB 100 |
| | | Grade 4 2,477 | | | | CSW 100 |
| | | Grade 5 2,539 | | | | |
| | | Grade 6 2,602 | | | | |
| | | Grade 7 3,673 | | | | |
| | | Grade 8 2,727 | | | | |

CU130

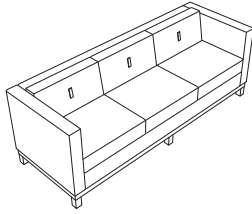

| Description | Dimensions (in) | | Dimensions (mm) | | | |
|---------------------|-----------------|------|-----------------|----------------|------|------|
| Sofa | Seat width | 71 ½ | 1816 | Overall width | 79 ½ | 2019 |
| Metal base included | Seat depth | 18 ½ | 470 | Overall depth | 29 ½ | 750 |
| | Seat height | 17 ¼ | 438 | Overall height | 28 | 712 |
| | Back height | 10 ¾ | 273 | | | |

| Model | Frame | Upholstery / List (\$) | Button (\$) | Tablet arm (\$) | Tablet finis | Other options (\$) |
|--------------|---------------|------------------------|---------------|-----------------------|------------------------------|---------------------------|
| CU130 | E8 Std | Grade 1 2,883 | A Std | NA Std | NA Std | DH 150 |
| | E9 N/C | Grade 2 2,943 | SA N/C | TAL 407 | Specify laminate code | PC (1x) 600 |
| | | Grade 3 3,018 | | TAR 407 | | CSB 150 |
| | | Grade 4 3,093 | | | | CSW 150 |
| | | Grade 5 3,168 | | | | |
| | | Grade 6 3,243 | | | | |
| | | Grade 7 4,936 | | | | |
| | | Grade 8 3,393 | | | | |

MODULAR, LOUNGE, AND PUBLIC AREAS

SPECIFICATIONS

- Storage units and tables ship assembled. Minimum assembly is required to mount units to the base.
- Fabric/fabric, fabric/vinyl and vinyl/vinyl dual upholstery is available. The first upholstery code is the backrest and a seat cushion, the second upholstery code is for the arms and structure. As for the ottoman, the first upholstery code is seat cushion, the second upholstery code is for the under structure.
- If dual upholstery combination is from two different grades, list price is the highest grade of the two.
- Higher back optional feature adds 3" to the back cushion only.
- Tablet arm cannot be retrofitted on existing model.
- If optional electrical module is selected, the module will be located in the left side of the front structure.
- 14-gauge steel belt with 16-gauge steel legs.
- 3" soft dual wheel casters are available on the armchair only.
- Levelers allow up to 1 ½" height adjustment.
- Please refer to your Lacasse Sampler for laminate choices.
- Please refer to accessories on page 53 for ganging brackets and floor anchors.
- C.O.M./C.O.V.: please refer to page 54.
- Units from this series were tested and successfully met ANSI/BIFMA X5.4-2012 standards.

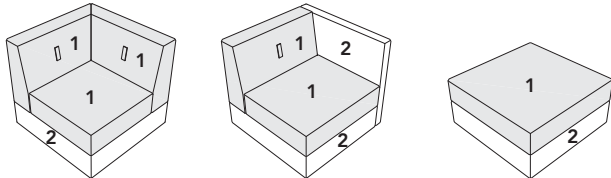

DUAL UPHOLSTERY APPLICATION

SAMPLE ORDER: CU201-CS009-CS009-PC

1
2

SAMPLE ORDER: CU201-CS009-CS009-PC

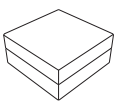
| CU201 | Description | | Dimensions | | (in) | (mm) | Dimensions | | (in) | (mm) | |
|-------|--|---------|-------------|------------|------|---------------|---------------|------|------|------------|------|
| |  | Ottoman | | Seat width | 24 ½ | 622 | Overall width | 24 ½ | 622 | Seat depth | 24 ½ |
| | | | Seat height | 17 ¼ | 438 | Overall depth | 17 ¼ | 438 | | | |

| Model | Upholstery / List (\$) | Other options (\$) |
|-------|------------------------|--------------------|
| CU201 | Grade 1 469 | PC (1x) 600 |
| | Grade 2 478 | CSB 50 |
| | Grade 3 489 | CSW 50 |
| | Grade 4 500 | |
| | Grade 5 511 | |
| | Grade 6 522 | |
| | Grade 7 820 | |
| | Grade 8 543 | |

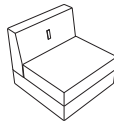
| CU202 | Description | | Dimensions | | (in) | (mm) | Dimensions | | (in) | (mm) | |
|-------|--|---------------|-------------|------------|------|----------------|---------------|------|-------------|------------|------|
| |  | Armless chair | | Seat width | 24 ½ | 622 | Overall width | 24 ½ | 622 | Seat depth | 24 ½ |
| | | | Seat height | 17 ¼ | 438 | Overall depth | 17 ¼ | 438 | Back height | 28 | 712 |
| | | | Back height | 10 ¾ | 273 | Overall height | 10 ¾ | 273 | | | |

| Model | Upholstery / List (\$) | Button (\$) | Other options (\$) |
|-------|------------------------|-------------|--------------------|
| CU202 | Grade 1 775 | A Std | DH 50 |
| | Grade 2 789 | SA N/C | CSB 50 |
| | Grade 3 806 | | CSW 50 |
| | Grade 4 824 | | PC (1x) 600 |
| | Grade 5 841 | | |
| | Grade 6 858 | | |
| | Grade 7 1,412 | | |
| | Grade 8 892 | | |

CU203

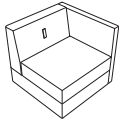

| Description | Dimensions (in) | (mm) | Dimensions (in) | (mm) | | |
|--------------------|-----------------|------|-----------------|----------------|------|-----|
| Left-side armchair | Seat width | 22 | 558 | Overall width | 24 ½ | 622 |
| | Seat depth | 18 ½ | 470 | Overall depth | 24 ½ | 622 |
| | Seat height | 17 ¼ | 438 | Overall height | 28 | 712 |
| | Back height | 10 ¾ | 273 | | | |

| Model | Upholstery / List (\$) | Button (\$) | Tablet arm (\$) | Tablet finis | Other options (\$) | |
|--------------|------------------------|-------------|-----------------|--------------|-----------------------|-------------|
| CU203 | Grade 1 | 901 | A Std | NA Std | NA Std | DH 50 |
| | Grade 2 | 917 | SA N/C | TAL 407 | Specify laminate code | CSB 50 |
| | Grade 3 | 938 | | | | CSW 50 |
| | Grade 4 | 958 | | | | PC (1x) 600 |
| | Grade 5 | 979 | | | | |
| | Grade 6 | 1,000 | | | | |
| | Grade 7 | 1,537 | | | | |
| | Grade 8 | 1,041 | | | | |

CU204

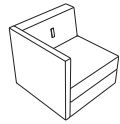

| Description | Dimensions (in) | (mm) | Dimensions (in) | (mm) | | |
|---------------------|-----------------|------|-----------------|----------------|------|-----|
| Right-side armchair | Seat width | 22 | 712 | Overall width | 24 ½ | 622 |
| | Seat depth | 18 ½ | 470 | Overall depth | 24 ½ | 622 |
| | Seat height | 17 ¼ | 438 | Overall height | 28 | 712 |
| | Back height | 10 ¾ | 273 | | | |

| Model | Upholstery / List (\$) | Button (\$) | Tablet arm (\$) | Tablet finis | Other options (\$) | |
|--------------|------------------------|-------------|-----------------|--------------|-----------------------|-------------|
| CU204 | Grade 1 | 901 | A Std | NA Std | NA Std | DH 50 |
| | Grade 2 | 917 | SA N/C | TAR 407 | Specify laminate code | CSB 50 |
| | Grade 3 | 938 | | | | CSW 50 |
| | Grade 4 | 958 | | | | PC (1x) 600 |
| | Grade 5 | 979 | | | | |
| | Grade 6 | 1,000 | | | | |
| | Grade 7 | 1,537 | | | | |
| | Grade 8 | 1,041 | | | | |

CU205

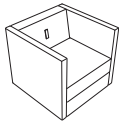

| Description | Dimensions (in) | (mm) | Dimensions (in) | (mm) | | |
|-------------|-----------------|------|-----------------|----------------|------|-----|
| Armchair | Seat width | 18 | 457 | Overall width | 24 ½ | 622 |
| | Seat depth | 18 ½ | 470 | Overall depth | 24 ½ | 622 |
| | Seat height | 17 ¼ | 438 | Overall height | 28 | 712 |
| | Back height | 10 ¾ | 273 | | | |

| Model | Upholstery / List (\$) | Button (\$) | Tablet arm (\$) | Tablet finis | Other options (\$) | |
|--------------|------------------------|-------------|-----------------|--------------|-----------------------|-------------|
| CU205 | Grade 1 | 1,007 | A Std | NA Std | NA Std | DH 50 |
| | Grade 2 | 1,029 | SA N/C | TAL 407 | Specify laminate code | CSB 50 |
| | Grade 3 | 1,058 | | TAR 407 | | CSW 50 |
| | Grade 4 | 1,086 | | | | PC (1x) 600 |
| | Grade 5 | 1,114 | | | | |
| | Grade 6 | 1,142 | | | | |
| | Grade 7 | 1,808 | | | | |
| | Grade 8 | 1,198 | | | | |

CU206

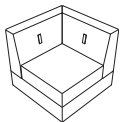

| Description | Dimensions (in) | (mm) | Dimensions (in) | (mm) | | |
|-----------------|-----------------|------|-----------------|----------------|------|-----|
| Corner armchair | Seat width | 18 ½ | 470 | Overall width | 24 ½ | 622 |
| | Seat depth | 18 ½ | 470 | Overall depth | 24 ½ | 622 |
| | Seat height | 17 ¼ | 438 | Overall height | 28 | 712 |
| | Back height | 10 ¾ | 273 | | | |

| Model | Upholstery / List (\$) | Button (\$) | Other options (\$) |
|--------------|------------------------|-------------|--------------------|
| CU206 | Grade 1 | 1,051 | A Std DH 100 |
| | Grade 2 | 1,067 | SA N/C CSB 50 |
| | Grade 3 | 1,088 | CSW 50 |
| | Grade 4 | 1,108 | |
| | Grade 5 | 1,129 | |
| | Grade 6 | 1,150 | |
| | Grade 7 | 1,687 | |
| | Grade 8 | 1,191 | |

CU2-TS

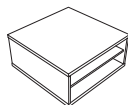

| Description | Dimensions | (in) | (mm) |
|---|----------------|------|------|
| Single access storage unit Metal base not included | Overall width | 24 ½ | 622 |
| | Overall depth | 24 ½ | 622 |
| | Overall height | 17 ¼ | 438 |

| Model | List (\$) | Laminate finis |
|--------|-----------|----------------|
| CU2-TS | 475 | Specify code |

CU2-TD

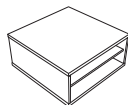

| Description | Dimensions | (in) | (mm) |
|---|----------------|------|------|
| Double access storage unit Metal base not included | Overall width | 24 ½ | 622 |
| | Overall depth | 24 ½ | 622 |
| | Overall height | 17 ¼ | 438 |

| Model | List (\$) | Laminate finis |
|--------|-----------|----------------|
| CU2-TD | 507 | Specify code |

CU2-TSP

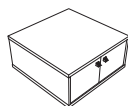

| Description | Dimensions | (in) | (mm) |
|--|----------------|------|------|
| Single access storage unit with doors Metal base not included | Overall width | 24 ½ | 622 |
| | Overall depth | 24 ½ | 622 |
| | Overall height | 17 ¼ | 438 |

| Model | List (\$) | Laminate finis |
|---------|-----------|----------------|
| CU2-TSP | 594 | Specify code |

CU2-TDP

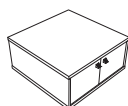

| Description | Dimensions | (in) | (mm) |
|--|----------------|------|------|
| Double access storage unit with doors Metal base not included | Overall width | 24 ½ | 622 |
| | Overall depth | 24 ½ | 622 |
| | Overall height | 17 ¼ | 438 |

| Model | List (\$) | Laminate finis |
|---------|-----------|----------------|
| CU2-TDP | 688 | Specify code |

CU2-TF

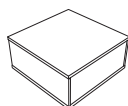

| Description | Dimensions | (in) | (mm) |
|--|----------------|------|------|
| Closed unit Metal base not included | Overall width | 24 ½ | 622 |
| | Overall depth | 24 ½ | 622 |
| | Overall height | 17 ¼ | 438 |

| Model | List (\$) | Laminate finis |
|--------|-----------|----------------|
| CU2-TF | 488 | Specify code |

CU2B1M

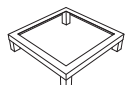

| Description | Dimensions | (in) | (mm) |
|--|----------------|------|------|
| Single-section metal base Hardware included | Overall width | 23 ¾ | 603 |
| | Overall depth | 23 ¾ | 603 |
| | Overall height | 5 ¾ | 136 |

| Model | Frame | List (\$) | Other options (\$) |
|--------|--------|-----------|--------------------|
| CU2B1M | E8 Std | 350 | SDW 85 |
| | E9 N/C | | |

CU2B2M

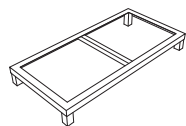

| Description | Dimensions | (in) | (mm) |
|--|----------------|------|------|
| Double-section metal base Hardware included | Overall width | 48 ¼ | 1226 |
| | Overall depth | 23 ¾ | 603 |
| | Overall height | 5 ¾ | 136 |

| Model | Frame | List (\$) |
|--------|--------|-----------|
| CU2B2M | E8 Std | 500 |
| | E9 N/C | |

CU2B3M

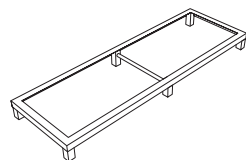

| Description | Dimensions | (in) | (mm) |
|--|----------------|------|------|
| Triple-section metal base Hardware included | Overall width | 72 ¾ | 1848 |
| | Overall depth | 23 ¾ | 603 |
| | Overall height | 5 ¾ | 136 |

| Model | Frame | List (\$) |
|--------|--------|-----------|
| CU2B3M | E8 Std | 600 |
| | E9 N/C | |

CU2-T2424

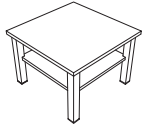

Description
Square table

| Dimensions | (in) | (mm) |
|----------------|------|------|
| Overall width | 24 ½ | 622 |
| Overall depth | 24 ½ | 622 |
| Overall height | 17 ¼ | 438 |

| Model | Frame | List (\$) | Laminate finish |
|-----------|--------|-----------|-----------------|
| CU2-T2424 | E8 Std | 657 | Specify code |
| | E9 N/C | | |

CU2-T2448

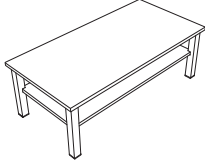

Description
Rectangular table

| Dimensions | (in) | (mm) |
|----------------|------|------|
| Overall width | 49 | 1245 |
| Overall depth | 24 ½ | 622 |
| Overall height | 17 ¼ | 438 |

| Model | Frame | List (\$) | Laminate finish |
|-----------|--------|-----------|-----------------|
| CU2-T2448 | E8 Std | 826 | Specify code |
| | E9 N/C | | |

CUBE 200 – SOLUTIONS

CUBE 200 – S1

\$1,764



- 1 CU205-A-TAR
- 1 CU2B1M

CUBE 200 – S2

\$2,877

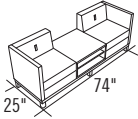

- 1 CU203
- 1 CU204
- 1 CU2-TS
- 1 CU2B3M

CUBE 200 – S3

\$5,946

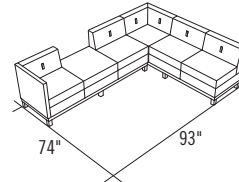

- 1 CU201
- 3 CU202
- 1 CU204
- 1 CU206
- 2 CU2B3M

MODULAR, LOUNGE, AND PUBLIC AREAS

SPECIFICATIONS

- Storage units and tables ship assembled. Minimum assembly is required to mount units to the base.
- Fabric/fabric, fabric/vinyl and vinyl/vinyl dual upholstery is available. The first upholstery code is the backrest and a seat cushion, the second upholstery code is for the arms and structure. As for the ottoman, the first upholstery code is seat cushion, the second upholstery code is for the under structure.
- If dual upholstery combination is from two different grades, list price is the highest grade of the two.
- Tablet arm cannot be retrofitted on existing model.
- If optional electrical module is selected, the module will be located in left side of the front structure.
- 16-gauge steel base and belt.
- 3" soft dual wheel casters are available on the armchair only.
- Levelers allow up to 1 ½" height adjustment.
- Please refer to your Lacasse Sampler for laminate choices.
- Please refer to accessories on page 53 for ganging brackets and floor anchors.
- C.O.M./C.O.V.: please refer to page 54.
- Units from this series were tested and successfully met ANSI/BIFMA X5.4-2012 standards.

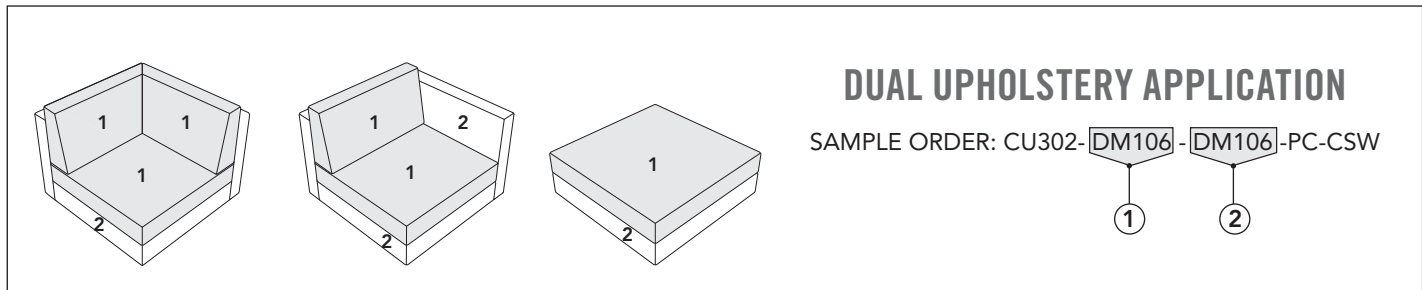

SAMPLE ORDER: CU302-DM106-DM106-PC-CSW

CU301

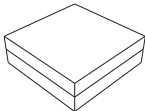

| Description | Dimensions | (in) | (mm) | Dimensions | (in) | (mm) |
|-------------|-------------|------|------|----------------|------|------|
| Ottoman | Seat width | 30 ½ | 781 | Overall width | 30 ½ | 775 |
| | Seat depth | 30 ½ | 781 | Overall depth | 30 ½ | 775 |
| | Seat height | 18 | 457 | Overall height | 18 | 457 |

| Model | Upholstery / List (\$) | Other options (\$) |
|-------|------------------------|--------------------|
| CU301 | Grade 1 | 588 |
| | Grade 2 | 599 |
| | Grade 3 | 613 |
| | Grade 4 | 626 |
| | Grade 5 | 640 |
| | Grade 6 | 654 |
| | Grade 7 | 1,137 |
| | Grade 8 | 681 |
| | PC (1x) | 600 |
| | CSB | 50 |
| | CSW | 50 |

CU302

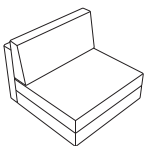

| Description | Dimensions | (in) | (mm) | Dimensions | (in) | (mm) |
|---------------|-------------|------|------|----------------|------|------|
| Armless chair | Seat width | 30 | 762 | Overall width | 30 ½ | 775 |
| | Seat depth | 19 ¾ | 502 | Overall depth | 30 ½ | 775 |
| | Seat height | 18 | 457 | Overall height | 32 ¾ | 832 |
| | Back height | 14 ¾ | 375 | | | |

| Model | Upholstery / List (\$) | Other options (\$) |
|-------|------------------------|--------------------|
| CU302 | Grade 1 | 938 |
| | Grade 2 | 960 |
| | Grade 3 | 988 |
| | Grade 4 | 1,015 |
| | Grade 5 | 1,043 |
| | Grade 6 | 1,070 |
| | Grade 7 | 1,761 |
| | Grade 8 | 1,125 |
| | PC (1x) | 600 |
| | CSB | 50 |
| | CSW | 50 |

CU303

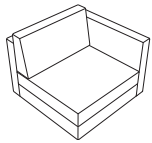

| Description | Dimensions (in) | (mm) | Dimensions (in) | (mm) |
|--------------------|-----------------|------|-----------------|----------------|
| Left-side armchair | Seat width | 27 | 686 | Overall width |
| | Seat depth | 19 ¾ | 502 | Overall depth |
| | Seat height | 18 | 457 | Overall height |
| | Back height | 14 ¾ | 375 | |

| Model | Upholstery / List (\$) | Tablet arm (\$) | Tablet finis | Other options (\$) |
|--------------|------------------------|-----------------|--------------|-----------------------|
| CU303 | Grade 1 | 1,101 | NA Std | NA Std |
| | Grade 2 | 1,126 | TAL 407 | Specify laminate code |
| | Grade 3 | 1,157 | | PC (1x) 600 |
| | Grade 4 | 1,188 | | CSB 50 |
| | Grade 5 | 1,220 | | CSW 50 |
| | Grade 6 | 1,251 | | |
| | Grade 7 | 2,089 | | |
| | Grade 8 | 1,313 | | |

CU304

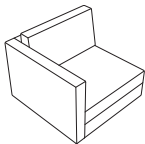

| Description | Dimensions (in) | (mm) | Dimensions (in) | (mm) |
|---------------------|-----------------|------|-----------------|----------------|
| Right-side armchair | Seat width | 27 | 686 | Overall width |
| | Seat depth | 19 ¾ | 502 | Overall depth |
| | Seat height | 18 | 457 | Overall height |
| | Back height | 14 ¾ | 375 | |

| Model | Upholstery / List (\$) | Tablet arm (\$) | Tablet finis | Other options (\$) |
|--------------|------------------------|-----------------|--------------|-----------------------|
| CU304 | Grade 1 | 1,101 | NA Std | NA Std |
| | Grade 2 | 1,126 | TAL 407 | Specify laminate code |
| | Grade 3 | 1,157 | | PC (1x) 600 |
| | Grade 4 | 1,188 | | CSB 50 |
| | Grade 5 | 1,220 | | CSW 50 |
| | Grade 6 | 1,251 | | |
| | Grade 7 | 2,089 | | |
| | Grade 8 | 1,313 | | |

CU305

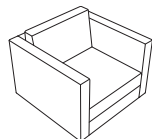

| Description | Dimensions (in) | (mm) | Dimensions (in) | (mm) |
|-------------|-----------------|------|-----------------|----------------|
| Armchair | Seat width | 24 | 610 | Overall width |
| | Seat depth | 19 ¾ | 502 | Overall depth |
| | Seat height | 18 | 457 | Overall height |
| | Back height | 14 ¾ | 375 | |

| Model | Upholstery / List (\$) | Tablet arm (\$) | Tablet finis | Other options (\$) |
|--------------|------------------------|-----------------|--------------|-----------------------|
| CU305 | Grade 1 | 1,238 | NA Std | NA Std |
| | Grade 2 | 1,266 | TAL 407 | Specify laminate code |
| | Grade 3 | 1,300 | TAR 407 | PC (1x) 600 |
| | Grade 4 | 1,335 | | CSB 50 |
| | Grade 5 | 1,369 | | CSW 50 |
| | Grade 6 | 1,403 | | |
| | Grade 7 | 2,501 | | |
| | Grade 8 | 1,472 | | |

CU306

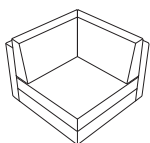

| Description | Dimensions (in) | (mm) | Dimensions (in) | (mm) |
|-----------------|-----------------|------|-----------------|----------------|
| Corner armchair | Seat width | 19 ¾ | 502 | Overall width |
| | Seat depth | 19 ¾ | 502 | Overall depth |
| | Seat height | 18 | 457 | Overall height |
| | Back height | 14 ¾ | 375 | |

| Model | Upholstery / List (\$) | Other options (\$) |
|--------------|------------------------|--------------------|
| CU306 | Grade 1 | 1,345 |
| | Grade 2 | 1,372 |
| | Grade 3 | 1,407 |
| | Grade 4 | 1,441 |
| | Grade 5 | 1,475 |
| | Grade 6 | 1,510 |
| | Grade 7 | 2,607 |
| | Grade 8 | 1,579 |

CU3-TS

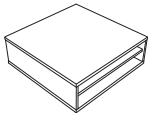

| Description | Dimensions | (in) | (mm) |
|---|----------------|------|------|
| Single access storage unit Metal base not included | Overall width | 30 ½ | 775 |
| | Overall depth | 30 ½ | 775 |
| | Overall height | 18 | 457 |

| Model | List (\$) | Laminate finis | |
|--------|-----------|----------------|--|
| CU3-TS | 600 | Specify code | |

CU3-TD

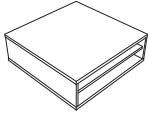

| Description | Dimensions | (in) | (mm) |
|---|----------------|------|------|
| Double access storage unit Metal base not included | Overall width | 30 ½ | 775 |
| | Overall depth | 30 ½ | 775 |
| | Overall height | 18 | 457 |

| Model | List (\$) | Laminate finis | |
|--------|-----------|----------------|--|
| CU3-TD | 657 | Specify code | |

CU3-TF

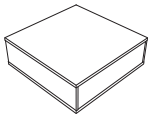

| Description | Dimensions | (in) | (mm) |
|--|----------------|------|------|
| Closed unit Metal base not included | Overall width | 30 ½ | 775 |
| | Overall depth | 30 ½ | 775 |
| | Overall height | 18 | 457 |

| Model | List (\$) | Laminate finis | |
|--------|-----------|----------------|--|
| CU3-TF | 613 | Specify code | |

CU3B1M

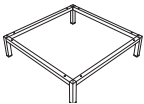

| Description | Dimensions | (in) | (mm) |
|--|----------------|------|------|
| Single-section metal base Hardware included | Overall width | 29 ¾ | 756 |
| | Overall depth | 29 ¾ | 756 |
| | Overall height | 7 ¾ | 197 |

| Model | Frame | List (\$) | Other options (\$) |
|--------|--------|-----------|--------------------|
| CU3B1M | E8 Std | 438 | SDW 85 |
| | E9 N/C | | |

CU3B2M

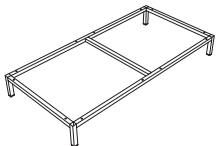

| Description | Dimensions | (in) | (mm) |
|--|----------------|------|------|
| Double-section metal base Hardware included | Overall width | 60 ¾ | 1530 |
| | Overall depth | 29 ¾ | 756 |
| | Overall height | 7 ¾ | 197 |

| Model | Frame | List (\$) | |
|--------|--------|-----------|--|
| CU3B2M | E8 Std | 532 | |
| | E9 N/C | | |

CU3B3M

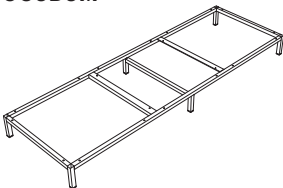

| Description | Dimensions | (in) | (mm) |
|--|----------------|------|------|
| Triple-section metal base Hardware included | Overall width | 90 ¾ | 2306 |
| | Overall depth | 29 ¾ | 756 |
| | Overall height | 7 ¾ | 197 |

| Model | Frame | List (\$) | |
|--------|--------|-----------|--|
| CU3B3M | E8 Std | 863 | |
| | E9 N/C | | |

CU3-T2424

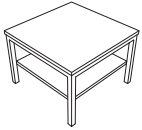

Description

Square table
Metal frame

| Dimensions | (in) | (mm) |
|----------------|------|------|
| Overall width | 24 ½ | 622 |
| Overall depth | 24 ½ | 622 |
| Overall height | 18 | 457 |

| Model | Frame | List (\$) | Laminate finis |
|-----------|------------------|-----------|----------------|
| CU3-T2424 | E8 Std E9 N/C | 813 | Specify code |

CU3-T3030

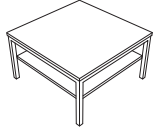

Description

Square table

| Dimensions | (in) | (mm) |
|----------------|------|------|
| Overall width | 30 ½ | 775 |
| Overall depth | 30 ½ | 775 |
| Overall height | 18 | 457 |

| Model | Frame | List (\$) | Laminate finis |
|-----------|------------------|-----------|----------------|
| CU3-T3030 | E8 Std E9 N/C | 988 | Specify code |

CU3-T2448

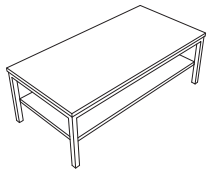

Description

Rectangular table
Metal frame

| Dimensions | (in) | (mm) |
|----------------|------|------|
| Overall width | 49 | 1245 |
| Overall depth | 24 ½ | 622 |
| Overall height | 18 | 457 |

| Model | Frame | List (\$) | Laminate finis |
|-----------|------------------|-----------|----------------|
| CU3-T2448 | E8 Std E9 N/C | 1,051 | Specify code |

CU3-T3030L

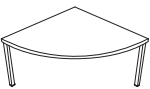

Description

Luna table
Metal frame

| Dimensions | (in) | (mm) |
|----------------|------|------|
| Overall width | 30 ½ | 775 |
| Overall depth | 30 ½ | 775 |
| Overall height | 18 | 457 |

| Model | Frame | List (\$) | Laminate finis |
|------------|------------------|-----------|----------------|
| CU3-T3030L | E8 Std E9 N/C | 782 | Specify code |

CUBE 300 – SOLUTIONS

CUBE 300 – S1

\$6,598

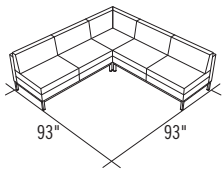

- 4 CU302
- 1 CU306
- 1 CU3B1M
- 2 CU3B2M

CUBE 300 – S4

\$9,431

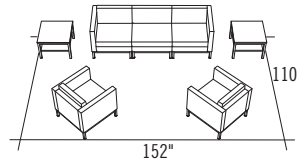

- 1 CU302
- 1 CU303
- 1 CU304
- 2 CU305
- 5 CU3B1M
- 2 CU3-T2424

CUBE 300 – S2

\$7,905

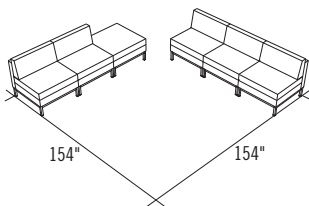

- 1 CU301
- 5 CU302
- 6 CU3B1M

CUBE 300 – S5

\$10,282

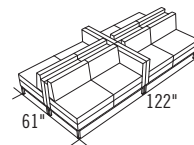

- 4 CU302
- 2 CU303
- 2 CU304
- 4 CU3B2M

CUBE 300 – S3

\$6,848

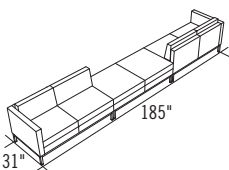

- 2 CU301
- 2 CU302
- 2 CU304
- 3 CU3B2M

CUBE 300 – S6

\$4,215

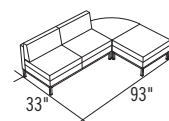

- 1 CU301
- 2 CU302
- 1 CU3-T3030L
- 1 CU3B1M
- 1 CU3B2M

LOUNGE

SPECIFICATIONS

- All models ship assembled.
- Fabric/fabric, fabric/vinyl and vinyl/vinyl dual upholstery is available. The first upholstery code is the backrest and seat shell, the second upholstery code is for the arms.
- If dual upholstery combination is from two different grades, list price is the highest grade of the two.
- Laminate tray to match legs and armrests wood finish.
- Refer to page 59 for the 4 wood finishes available.
- 2" hard dual wheel casters are available.
- C.O.M./C.O.V.: please refer to page 54.

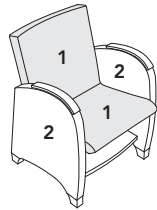

DUAL UPHOLSTERY APPLICATION

SAMPLE ORDER: FL1-W3-MG054-MG054-DCH

1

2

SAMPLE ORDER: FL1-W3-MG054-MG054-DCH

FL1



| Description | Dimensions | (in) | (mm) | Dimensions | (in) | (mm) |
|---------------------------|-------------|------|------|----------------|------|------|
| Armchair | Seat width | 21 ½ | 546 | Overall width | 27 ½ | 699 |
| Monocoque shell | Seat depth | 19 | 483 | Overall depth | 26 ½ | 673 |
| Wood armrests and legs | Seat height | 18 ½ | 470 | Overall height | 33 | 838 |
| Thermofused laminate tray | Back height | 18 | 457 | | | |

| Model | Frame | Upholstery / List (\$) | Laminate match | Other options (\$) |
|-------|--------|------------------------|----------------|--------------------|
| FL1 | W1 Std | Grade 1 1,232 | NTL (W1) | HDW 85 |
| | W2 N/C | Grade 2 1,250 | CER (W2) | |
| | W3 N/C | Grade 3 1,271 | DCH (W3) | |
| | W4 N/C | Grade 4 1,293 | TWT (W4) | |
| | | Grade 5 1,315 | | |
| | | Grade 6 1,337 | | |
| | | Grade 7 1,880 | | |
| | | Grade 8 1,381 | | |

HIP HOP AND HIP HOP JUNIOR

MODULAR, LOUNGE AND PUBLIC AREAS

SPECIFICATIONS

- All models ship assembled.
- Fabric/fabric, fabric/vinyl and vinyl/vinyl dual upholstery is available for the double ogive and chairs only. The first upholstery code is the backrest, the second upholstery code is for the seat.
- If dual upholstery combination is from two different grades, list price is the highest grade of the two.
- Leather is not available for these series.
- ¼" thick bended steel legs, 9 ½"H for Hip Hop and 6"H for Hip Hop Junior.
- Please refer to your Lacasse Sampler for laminate choices.
- Please refer to accessories on page 53 for ganging brackets.
- C.O.M./C.O.V.: please refer to page 54.

CALCULATING RADIUS:

The radius is the linear distance calculated from the center of the circle (point 0) to the inner circumference of the module.

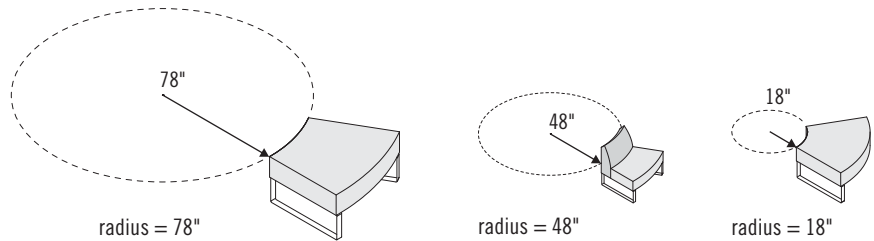

CALCULATING DEGREES:

The degree of the angle is calculated by dividing the entire circumference (360°) by the number of modules. E.g.: 360 divided by 6 modular units provides an angle of 60°. Thus, 12 modules of 30° form a circle (360°).

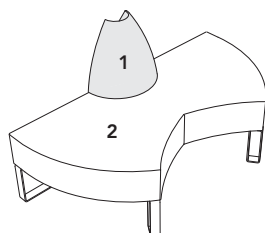
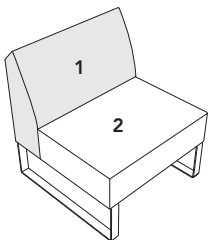
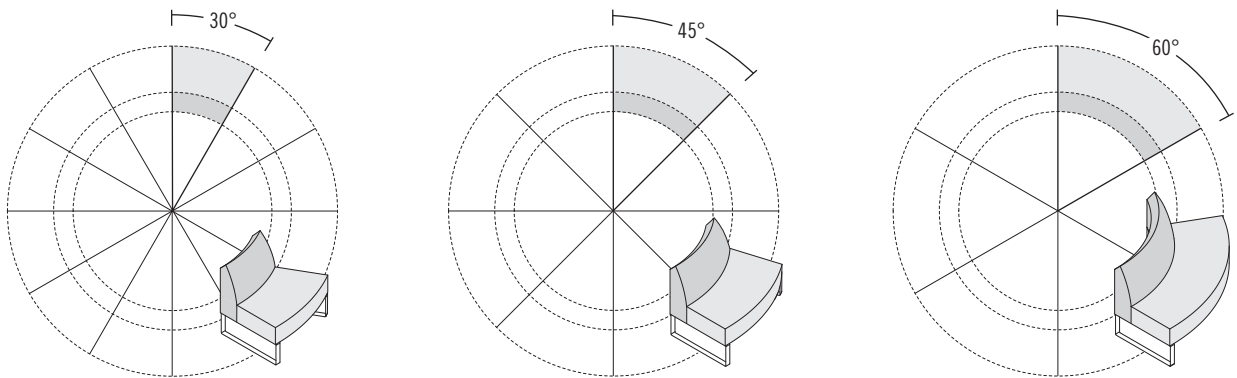

DUAL UPHOLSTERY APPLICATION

SAMPLE ORDER: HV-E9-CY32-HU10



HV

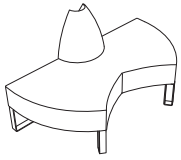

| Description | Dimensions (in) | (mm) | Dimensions (in) | (mm) | | |
|-------------------|-----------------|------|-----------------|----------------|----|------|
| Double ogive seat | Seat width | 60 | 1524 | Overall width | 60 | 1524 |
| | Seat depth | 21 | 533 | Overall depth | 30 | 762 |
| | Seat height | 18 | 457 | Overall height | 34 | 864 |
| | Back height | 16 | 406 | | | |

| Model | Frame | Upholstery / List (\$) | |
|-----------|---------------|------------------------|-------|
| HV | E8 Std | Grade 1 | 2,577 |
| | | Grade 2 | 2,592 |
| | E9 N/C | Grade 3 | 2,610 |
| | | Grade 4 | 2,629 |
| | | Grade 5 | 2,648 |
| | | Grade 6 | 2,667 |
| | | Grade 7 | |
| | | Grade 8 | 2,704 |

HO

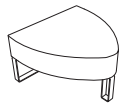

| Description | Dimensions (in) | (mm) | Dimensions (in) | (mm) | | |
|-------------|-----------------|------|-----------------|----------------|----|-----|
| Ogive | Seat width | 30 | 762 | Overall width | 30 | 762 |
| | Seat depth | 30 | 762 | Overall depth | 30 | 762 |
| | Seat height | 18 | 457 | Overall height | 18 | 457 |

| Model | Frame | Upholstery / List (\$) | |
|-----------|---------------|------------------------|-------|
| HO | E8 Std | Grade 1 | 1,226 |
| | | Grade 2 | 1,237 |
| | E9 N/C | Grade 3 | 1,251 |
| | | Grade 4 | 1,265 |
| | | Grade 5 | 1,279 |
| | | Grade 6 | 1,293 |
| | | Grade 7 | |
| | | Grade 8 | 1,321 |

H30

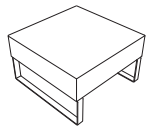

| Description | Dimensions (in) | (mm) | Dimensions (in) | (mm) | | |
|--------------|-----------------|------|-----------------|----------------|----|-----|
| Square bench | Seat width | 30 | 762 | Overall width | 30 | 762 |
| | Seat depth | 30 | 762 | Overall depth | 30 | 762 |
| | Seat height | 18 | 457 | Overall height | 18 | 457 |

| Model | Frame | Upholstery / List (\$) | |
|------------|---------------|------------------------|-------|
| H30 | E8 Std | Grade 1 | 969 |
| | | Grade 2 | 979 |
| | E9 N/C | Grade 3 | 992 |
| | | Grade 4 | 1,004 |
| | | Grade 5 | 1,017 |
| | | Grade 6 | 1,029 |
| | | Grade 7 | |
| | | Grade 8 | 1,054 |

H30X

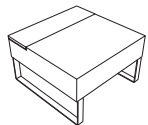

| Description | Dimensions (in) | (mm) | Dimensions (in) | (mm) | | |
|--------------------|-----------------|------|-----------------|----------------|----|-----|
| Mixed square bench | Seat width | 30 | 762 | Overall width | 30 | 762 |
| | Seat depth | 21 | 533 | Overall depth | 30 | 762 |
| | Seat height | 18 | 457 | Overall height | 18 | 457 |

| Model | Frame | Upholstery / List (\$) | | Tablet finis |
|-------------|---------------|------------------------|-------|-----------------------|
| H30X | E8 Std | Grade 1 | 1,144 | Specify laminate code |
| | | Grade 2 | 1,154 | |
| | E9 N/C | Grade 3 | 1,167 | |
| | | Grade 4 | 1,180 | |
| | | Grade 5 | 1,192 | |
| | | Grade 6 | 1,205 | |
| | | Grade 7 | | |
| | | Grade 8 | 1,230 | |

HC30

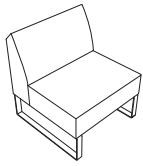

| Description | Dimensions (in) | (mm) | Dimensions (in) | (mm) | | |
|----------------|-----------------|------|-----------------|----------------|----|-----|
| Straight chair | Seat width | 30 | 762 | Overall width | 30 | 762 |
| | Seat depth | 21 | 533 | Overall depth | 30 | 762 |
| | Seat height | 18 | 457 | Overall height | 34 | 864 |
| | Back height | 16 | 406 | | | |
| | Back width | 30 | 762 | | | |

| Model | Frame | Upholstery / List (\$) | |
|-------------|--------|------------------------|-------|
| HC30 | E8 Std | Grade 1 | 1,370 |
| | | Grade 2 | 1,384 |
| | E9 N/C | Grade 3 | 1,402 |
| | | Grade 4 | 1,420 |
| | | Grade 5 | 1,439 |
| | | Grade 6 | 1,457 |
| | | Grade 7 | 1,475 |
| | | Grade 8 | 1,493 |

H60

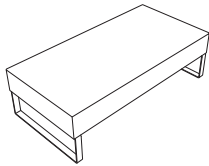

| Description | Dimensions (in) | (mm) | Dimensions (in) | (mm) | | |
|-------------------|-----------------|------|-----------------|----------------|----|------|
| Rectangular bench | Seat width | 60 | 1524 | Overall width | 60 | 1524 |
| | Seat depth | 30 | 762 | Overall depth | 30 | 762 |
| | Seat height | 18 | 457 | Overall height | 34 | 864 |
| | Back height | 16 | 406 | | | |

| Model | Frame | Upholstery / List (\$) | |
|------------|--------|------------------------|-------|
| H60 | E8 Std | Grade 1 | 1,582 |
| | | Grade 2 | 1,596 |
| | E9 N/C | Grade 3 | 1,613 |
| | | Grade 4 | 1,630 |
| | | Grade 5 | 1,646 |
| | | Grade 6 | 1,663 |
| | | Grade 7 | 1,680 |
| | | Grade 8 | 1,697 |

H60X

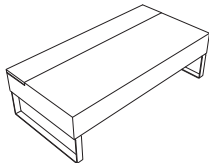

| Description | Dimensions (in) | (mm) | Dimensions (in) | (mm) | | |
|-------------------------|-----------------|------|-----------------|----------------|----|------|
| Mixed rectangular bench | Seat width | 60 | 1524 | Overall width | 60 | 1524 |
| | Seat depth | 30 | 762 | Overall depth | 30 | 762 |
| | Seat height | 18 | 457 | Overall height | 18 | 457 |

| Model | Frame | Upholstery / List (\$) | Tablet finis | |
|-------------|--------|------------------------|--------------|-----------------------|
| H60X | E8 Std | Grade 1 | 1,839 | |
| | | Grade 2 | 1,853 | |
| | E9 N/C | Grade 3 | 1,870 | Specify laminate code |
| | | Grade 4 | 1,888 | |
| | | Grade 5 | 1,905 | |
| | | Grade 6 | 1,923 | |
| | | Grade 7 | 1,940 | |
| | | Grade 8 | 1,958 | |

HC60

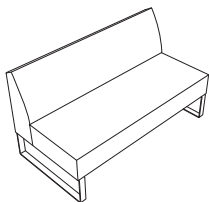

| Description | Dimensions (in) | (mm) | Dimensions (in) | (mm) | | |
|----------------|-----------------|------|-----------------|----------------|----|------|
| Straight chair | Seat width | 60 | 1524 | Overall width | 60 | 1524 |
| | Seat depth | 21 | 533 | Overall depth | 30 | 762 |
| | Seat height | 18 | 457 | Overall height | 34 | 864 |
| | Back height | 16 | 406 | | | |
| | Back width | 60 | 1524 | | | |

| Model | Frame | Upholstery / List (\$) | |
|-------------|--------|------------------------|-------|
| HC60 | E8 Std | Grade 1 | 2,201 |
| | | Grade 2 | 2,230 |
| | E9 N/C | Grade 3 | 2,266 |
| | | Grade 4 | 2,301 |
| | | Grade 5 | 2,337 |
| | | Grade 6 | 2,373 |
| | | Grade 7 | 2,409 |
| | | Grade 8 | 2,444 |

H1860

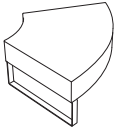

| Description | Dimensions | (in) | (mm) | Dimensions | (in) | (mm) |
|--------------|-------------|------|------|----------------|------|------|
| Wedge bench | Seat width | 48 | 1219 | Overall width | 48 | 1219 |
| Radius = 18" | Seat depth | 30 | 762 | Overall depth | 32 ½ | 826 |
| Degree = 60° | Seat height | 18 | 457 | Overall height | 18 | 457 |

| Model | Frame | Upholstery / List (\$) |
|-------|--------|------------------------|
| H1860 | E8 Std | Grade 1 1,532 |
| | | Grade 2 1,545 |
| | E9 N/C | Grade 3 1,560 |
| | | Grade 4 1,576 |
| | | Grade 5 1,592 |
| | | Grade 6 1,607 |
| | | Grade 7 1,623 |
| | | Grade 8 1,639 |

HX1860

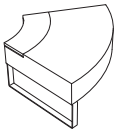

| Description | Dimensions | (in) | (mm) | Dimensions | (in) | (mm) |
|-------------------|-------------|------|------|----------------|------|------|
| Mixed wedge bench | Seat width | 48 | 1219 | Overall width | 48 | 1219 |
| Radius = 18" | Seat depth | 21 | 533 | Overall depth | 32 ½ | 826 |
| Degree = 60° | Seat height | 18 | 457 | Overall height | 18 | 457 |

| Model | Frame | Upholstery / List (\$) | Tablet finis |
|--------|--------|------------------------|-----------------------|
| HX1860 | E8 Std | Grade 1 1,745 | Specify laminate code |
| | | Grade 2 1,757 | |
| | E9 N/C | Grade 3 1,773 | |
| | | Grade 4 1,789 | |
| | | Grade 5 1,804 | |
| | | Grade 6 1,820 | |
| | | Grade 7 1,836 | |
| | | Grade 8 1,851 | |

H1860X

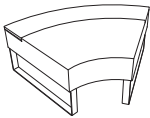

| Description | Dimensions | (in) | (mm) | Dimensions | (in) | (mm) |
|-------------------|-------------|------|------|----------------|------|------|
| Mixed wedge bench | Seat width | 39 | 991 | Overall width | 48 | 1219 |
| Radius = 18" | Seat depth | 21 | 533 | Overall depth | 32 ½ | 826 |
| Degree = 60° | Seat height | 18 | 457 | Overall height | 18 | 457 |

| Model | Frame | Upholstery / List (\$) | Tablet finis |
|--------|--------|------------------------|-----------------------|
| H1860X | E8 Std | Grade 1 1,745 | Specify laminate code |
| | | Grade 2 1,757 | |
| | E9 N/C | Grade 3 1,773 | |
| | | Grade 4 1,789 | |
| | | Grade 5 1,804 | |
| | | Grade 6 1,820 | |
| | | Grade 7 1,836 | |
| | | Grade 8 1,851 | |

HC1860

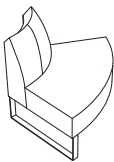

| Description | Dimensions | (in) | (mm) | Dimensions | (in) | (mm) |
|--------------|-------------|------|------|----------------|------|------|
| Wedge chair | Seat width | 48 | 1219 | Overall width | 48 | 1219 |
| Radius = 18" | Seat depth | 21 | 533 | Overall depth | 32 ½ | 826 |
| Degree = 60° | Seat height | 18 | 457 | Overall height | 34 | 864 |
| | Back height | 16 | 406 | | | |
| | Back width | 27 | 686 | | | |

| Model | Frame | Upholstery / List (\$) |
|--------|--------|------------------------|
| HC1860 | E8 Std | Grade 1 1,895 |
| | | Grade 2 1,915 |
| | E9 N/C | Grade 3 1,940 |
| | | Grade 4 1,965 |
| | | Grade 5 1,990 |
| | | Grade 6 2,015 |
| | | Grade 7 2,040 |
| | | Grade 8 2,065 |

H1860C

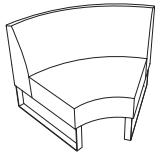

| Description | Dimensions (in) | (mm) | Dimensions (in) | (mm) | | |
|--------------|-----------------|------|-----------------|----------------|--------|------|
| Wedge chair | Seat width | 39 | 991 | Overall width | 48 | 1219 |
| Radius = 18" | Seat depth | 21 | 533 | Overall depth | 32 1/2 | 826 |
| Degree = 60° | Seat height | 18 | 457 | Overall height | 34 | 864 |
| | Back height | 16 | 406 | | | |
| | Back width | 39 | 991 | | | |

| Model | Frame | Upholstery / List (\$) | |
|--------|--------|------------------------|-------|
| H1860C | E8 Std | Grade 1 | 1,895 |
| | | Grade 2 | 1,916 |
| | E9 N/C | Grade 3 | 1,943 |
| | | Grade 4 | 1,969 |
| | | Grade 5 | 1,996 |
| | | Grade 6 | 2,023 |
| | | Grade 7 | |
| | | Grade 8 | 2,076 |

H4830

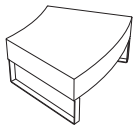

| Description | Dimensions (in) | (mm) | Dimensions (in) | (mm) | | |
|--------------|-----------------|--------|-----------------|----------------|--------|------|
| Wedge bench | Seat width | 40 1/4 | 1022 | Overall width | 40 1/4 | 1022 |
| Radius = 48" | Seat depth | 30 | 762 | Overall depth | 31 3/4 | 806 |
| Degree = 30° | Seat height | 18 | 457 | Overall height | 18 | 457 |

| Model | Frame | Upholstery / List (\$) | |
|-------|--------|------------------------|-------|
| H4830 | E8 Std | Grade 1 | 1,420 |
| | | Grade 2 | 1,431 |
| | E9 N/C | Grade 3 | 1,444 |
| | | Grade 4 | 1,458 |
| | | Grade 5 | 1,472 |
| | | Grade 6 | 1,486 |
| | | Grade 7 | |
| | | Grade 8 | 1,513 |

HX4830

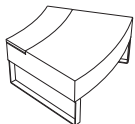

| Description | Dimensions (in) | (mm) | Dimensions (in) | (mm) | | |
|-------------------|-----------------|--------|-----------------|----------------|--------|------|
| Mixed wedge bench | Seat width | 40 1/4 | 1022 | Overall width | 40 1/4 | 1022 |
| Radius = 48" | Seat depth | 21 | 533 | Overall depth | 31 3/4 | 806 |
| Degree = 30° | Seat height | 18 | 457 | Overall height | 18 | 457 |

| Model | Frame | Upholstery / List (\$) | Tablet finis | |
|--------|--------|------------------------|--------------|-----------------------|
| HX4830 | E8 Std | Grade 1 | 1,632 | Specify laminate code |
| | | Grade 2 | 1,642 | |
| | E9 N/C | Grade 3 | 1,655 | |
| | | Grade 4 | 1,667 | |
| | | Grade 5 | 1,680 | |
| | | Grade 6 | 1,692 | |
| | | Grade 7 | | |
| | | Grade 8 | 1,717 | |

H4830X

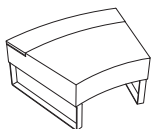

| Description | Dimensions (in) | (mm) | Dimensions (in) | (mm) | | |
|-------------------|-----------------|--------|-----------------|----------------|--------|------|
| Mixed wedge bench | Seat width | 35 3/4 | 909 | Overall width | 40 1/4 | 1022 |
| Radius = 48" | Seat depth | 21 | 533 | Overall depth | 31 3/4 | 806 |
| Degree = 30° | Seat height | 18 | 457 | Overall height | 18 | 457 |

| Model | Frame | Upholstery / List (\$) | Tablet finis | |
|--------|--------|------------------------|--------------|-----------------------|
| H4830X | E8 Std | Grade 1 | 1,632 | Specify laminate code |
| | | Grade 2 | 1,642 | |
| | E9 N/C | Grade 3 | 1,655 | |
| | | Grade 4 | 1,667 | |
| | | Grade 5 | 1,680 | |
| | | Grade 6 | 1,692 | |
| | | Grade 7 | | |
| | | Grade 8 | 1,717 | |

HC4830

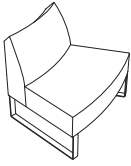

| Description | Dimensions | (in) | (mm) | Dimensions | (in) | (mm) |
|--------------|-------------|------|------|----------------|------|------|
| Wedge chair | Seat width | 40 ¼ | 1022 | Overall width | 40 ¼ | 1022 |
| Radius = 48" | Seat depth | 21 | 533 | Overall depth | 31 ¾ | 806 |
| Degree = 30° | Seat height | 18 | 457 | Overall height | 34 | 864 |
| | Back height | 16 | 406 | | | |
| | Back width | 29 ½ | 749 | | | |

| Model | Frame | Upholstery / List (\$) |
|--------|--------|------------------------|
| HC4830 | E8 Std | Grade 1 1,789 |
| | | Grade 2 1,809 |
| | E9 N/C | Grade 3 1,834 |
| | | Grade 4 1,859 |
| | | Grade 5 1,884 |
| | | Grade 6 1,909 |
| | | Grade 7 1,934 |
| | | Grade 8 1,959 |

H4830C

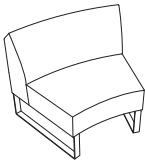

| Description | Dimensions | (in) | (mm) | Dimensions | (in) | (mm) |
|--------------|-------------|------|------|----------------|------|------|
| Wedge chair | Seat width | 35 ¾ | 909 | Overall width | 40 ¼ | 1022 |
| Radius = 48" | Seat depth | 21 | 533 | Overall depth | 31 ¾ | 806 |
| Degree = 30° | Seat height | 18 | 457 | Overall height | 34 | 864 |
| | Back height | 16 | 406 | | | |
| | Back width | 35 ¾ | 909 | | | |

| Model | Frame | Upholstery / List (\$) |
|--------|--------|------------------------|
| H4830C | E8 Std | Grade 1 1,789 |
| | | Grade 2 1,809 |
| | E9 N/C | Grade 3 1,834 |
| | | Grade 4 1,859 |
| | | Grade 5 1,884 |
| | | Grade 6 1,909 |
| | | Grade 7 1,934 |
| | | Grade 8 1,959 |

H4845

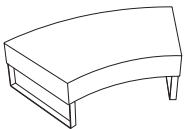

| Description | Dimensions | (in) | (mm) | Dimensions | (in) | (mm) |
|--------------|-------------|------|------|----------------|------|------|
| Wedge bench | Seat width | 60 | 1524 | Overall width | 60 | 1524 |
| Radius = 48" | Seat depth | 30 | 762 | Overall depth | 34 | 864 |
| Degree = 45° | Seat height | 18 | 457 | Overall height | 18 | 457 |

| Model | Frame | Upholstery / List (\$) |
|-------|--------|------------------------|
| H4845 | E8 Std | Grade 1 1,870 |
| | | Grade 2 1,882 |
| | E9 N/C | Grade 3 1,898 |
| | | Grade 4 1,914 |
| | | Grade 5 1,929 |
| | | Grade 6 1,945 |
| | | Grade 7 1,960 |
| | | Grade 8 1,976 |

HX4845

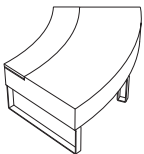

| Description | Dimensions | (in) | (mm) | Dimensions | (in) | (mm) |
|-------------------|-------------|------|------|----------------|------|------|
| Mixed wedge bench | Seat width | 60 | 1524 | Overall width | 60 | 1524 |
| Radius = 48" | Seat depth | 21 | 533 | Overall depth | 34 | 864 |
| Degree = 45° | Seat height | 18 | 457 | Overall height | 18 | 457 |

| Model | Frame | Upholstery / List (\$) | Tablet finis |
|--------|--------|------------------------|-----------------------|
| HX4845 | E8 Std | Grade 1 2,158 | Specify laminate code |
| | | Grade 2 2,170 | |
| | E9 N/C | Grade 3 2,186 | |
| | | Grade 4 2,201 | |
| | | Grade 5 2,217 | |
| | | Grade 6 2,233 | |
| | | Grade 7 2,248 | |
| | | Grade 8 2,264 | |

H4845X

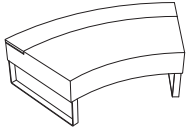

| Description | Dimensions (in) | (mm) | Dimensions (in) | (mm) | | |
|-------------------|-----------------|------|-----------------|----------------|----|------|
| Mixed wedge bench | Seat width | 53 | 1346 | Overall width | 60 | 1524 |
| Radius = 48" | Seat depth | 21 | 533 | Overall depth | 34 | 864 |
| Degree = 45° | Seat height | 18 | 457 | Overall height | 18 | 457 |

| Model | Frame | Upholstery / List (\$) | Tablet finis |
|---------------|---------------|------------------------|--------------|
| H4845X | E8 Std | Grade 1 | 2,158 |
| | | Grade 2 | 2,170 |
| | E9 N/C | Grade 3 | 2,186 |
| | | Grade 4 | 2,201 |
| | Grade 5 | 2,217 | |
| | Grade 6 | 2,233 | |
| | Grade 7 | 2,249 | |
| | Grade 8 | 2,264 | |

HC4845

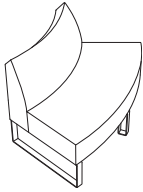

| Description | Dimensions (in) | (mm) | Dimensions (in) | (mm) | | |
|--------------|-----------------|--------|-----------------|----------------|----|------|
| Wedge chair | Seat width | 44 | 1118 | Overall width | 60 | 1524 |
| Radius = 48" | Seat depth | 21 | 533 | Overall depth | 34 | 864 |
| Degree = 45° | Seat height | 18 | 457 | Overall height | 34 | 864 |
| | Back height | 16 | 406 | | | |
| | Back width | 43 3/8 | 1108 | | | |

| Model | Frame | Upholstery / List (\$) | |
|---------------|---------------|------------------------|--------------|
| HC4845 | E8 Std | Grade 1 | 2,364 |
| | | Grade 2 | 2,389 |
| | E9 N/C | Grade 3 | 2,420 |
| | | Grade 4 | 2,452 |
| | Grade 5 | 2,483 | |
| | Grade 6 | 2,514 | |
| | Grade 7 | 2,545 | |
| | Grade 8 | 2,577 | |

H4845C

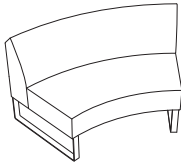

| Description | Dimensions (in) | (mm) | Dimensions (in) | (mm) | | |
|--------------|-----------------|------|-----------------|----------------|----|------|
| Wedge chair | Seat width | 53 | 1346 | Overall width | 60 | 1524 |
| Radius = 48" | Seat depth | 21 | 533 | Overall depth | 34 | 864 |
| Degree = 45° | Seat height | 18 | 457 | Overall height | 34 | 864 |
| | Back height | 16 | 406 | | | |
| | Back width | 53 | 1346 | | | |

| Model | Frame | Upholstery / List (\$) | |
|---------------|---------------|------------------------|--------------|
| H4845C | E8 Std | Grade 1 | 2,364 |
| | | Grade 2 | 2,389 |
| | E9 N/C | Grade 3 | 2,420 |
| | | Grade 4 | 2,452 |
| | Grade 5 | 2,483 | |
| | Grade 6 | 2,514 | |
| | Grade 7 | 2,545 | |
| | Grade 8 | 2,577 | |

H4860

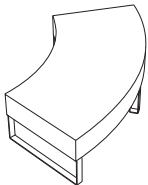

| Description | Dimensions (in) | (mm) | Dimensions (in) | (mm) | | |
|--------------|-----------------|------|-----------------|----------------|----|------|
| Wedge bench | Seat width | 78 | 1981 | Overall width | 78 | 1981 |
| Radius = 48" | Seat depth | 30 | 762 | Overall depth | 37 | 940 |
| Degree = 60° | Seat height | 18 | 457 | Overall height | 18 | 457 |

| Model | Frame | Upholstery / List (\$) | |
|--------------|---------------|------------------------|--------------|
| H4860 | E8 Std | Grade 1 | 2,258 |
| | | Grade 2 | 2,273 |
| | E9 N/C | Grade 3 | 2,291 |
| | | Grade 4 | 2,310 |
| | Grade 5 | 2,329 | |
| | Grade 6 | 2,348 | |
| | Grade 7 | 2,367 | |
| | Grade 8 | 2,385 | |

HX4860

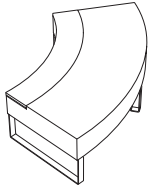

| Description | | Dimensions (in) | | Dimensions (mm) | | Dimensions (in) | | Dimensions (mm) | |
|-------------------|--|-----------------|----|-----------------|----------------|-----------------|------|-----------------|--|
| Mixed wedge bench | | Seat width | 78 | 1981 | Overall width | 78 | 1981 | | |
| Radius = 48" | | Seat depth | 21 | 533 | Overall depth | 37 | 940 | | |
| Degree = 60° | | Seat height | 18 | 457 | Overall height | 18 | 457 | | |

| Model | Frame | Upholstery / List (\$) | | Tablet finis |
|---------|--------|------------------------|-------|-----------------------|
| HX4860 | E8 Std | Grade 1 | 2,564 | Specify laminate code |
| | E9 N/C | Grade 2 | 2,579 | |
| Grade 3 | | 2,598 | | |
| Grade 4 | | 2,617 | | |
| Grade 5 | | 2,635 | | |
| Grade 6 | | 2,654 | | |
| Grade 8 | | 2,692 | | |

H4860X

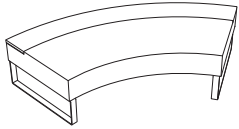

| Description | | Dimensions (in) | | Dimensions (mm) | | Dimensions (in) | | Dimensions (mm) | |
|-------------------|--|-----------------|----|-----------------|----------------|-----------------|------|-----------------|--|
| Mixed wedge bench | | Seat width | 57 | 1448 | Overall width | 78 | 1981 | | |
| Radius = 48" | | Seat depth | 21 | 533 | Overall depth | 37 | 940 | | |
| Degree = 60° | | Seat height | 18 | 457 | Overall height | 18 | 457 | | |

| Model | Frame | Upholstery / List (\$) | | Tablet finis |
|---------|--------|------------------------|-------|-----------------------|
| H4860X | E8 Std | Grade 1 | 2,564 | Specify laminate code |
| | E9 N/C | Grade 2 | 2,579 | |
| Grade 3 | | 2,598 | | |
| Grade 4 | | 2,617 | | |
| Grade 5 | | 2,635 | | |
| Grade 6 | | 2,654 | | |
| Grade 8 | | 2,692 | | |

HC4860

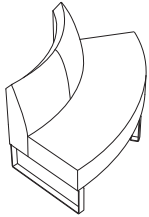

| Description | | Dimensions (in) | | Dimensions (mm) | | Dimensions (in) | | Dimensions (mm) | |
|--------------|--|-----------------|----|-----------------|----------------|-----------------|------|-----------------|--|
| Wedge chair | | Seat width | 78 | 1981 | Overall width | 78 | 1981 | | |
| Radius = 48" | | Seat depth | 21 | 533 | Overall depth | 37 | 940 | | |
| Degree = 60° | | Seat height | 18 | 457 | Overall height | 34 | 864 | | |
| | | Back height | 16 | 406 | | | | | |
| | | Back width | 57 | 1448 | | | | | |

| Model | Frame | Upholstery / List (\$) | | Tablet finis |
|---------|--------|------------------------|-------|--------------|
| HC4860 | E8 Std | Grade 1 | 2,977 | |
| | E9 N/C | Grade 2 | 3,005 | |
| Grade 3 | | 3,041 | | |
| Grade 4 | | 3,077 | | |
| Grade 5 | | 3,112 | | |
| Grade 6 | | 3,148 | | |
| Grade 8 | | 3,219 | | |

H4860C

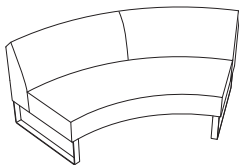

| Description | | Dimensions (in) | | Dimensions (mm) | | Dimensions (in) | | Dimensions (mm) | |
|--------------|--|-----------------|--------|-----------------|----------------|-----------------|------|-----------------|--|
| Wedge chair | | Seat width | 69 1/4 | 1759 | Overall width | 78 | 1981 | | |
| Radius = 48" | | Seat depth | 21 | 533 | Overall depth | 37 | 940 | | |
| Degree = 60° | | Seat height | 18 | 457 | Overall height | 34 | 864 | | |
| | | Back height | 16 | 406 | | | | | |
| | | Back width | 69 1/4 | 1759 | | | | | |

| Model | Frame | Upholstery / List (\$) | | Tablet finis |
|---------|--------|------------------------|-------|--------------|
| H4860C | E8 Std | Grade 1 | 2,977 | |
| | E9 N/C | Grade 2 | 3,007 | |
| Grade 3 | | 3,044 | | |
| Grade 4 | | 3,082 | | |
| Grade 5 | | 3,119 | | |
| Grade 6 | | 3,157 | | |
| Grade 8 | | 3,232 | | |

H7830

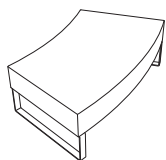

| Description | Dimensions (in) | (mm) | Dimensions (in) | (mm) |
|--------------|-----------------|------|-----------------|----------------|
| Wedge bench | Seat width | 56 | 1422 | Overall width |
| Radius = 78" | Seat depth | 30 | 762 | Overall depth |
| Degree = 30° | Seat height | 18 | 457 | Overall height |

| Model | Frame | Upholstery / List (\$) |
|-------|--------|------------------------|
| H7830 | E8 Std | Grade 1 1,745 |
| | E9 N/C | Grade 2 1,760 |
| | | Grade 3 1,779 |
| | | Grade 4 1,797 |
| | | Grade 5 1,816 |
| | | Grade 6 1,835 |
| | | Grade 8 1,872 |

HX7830

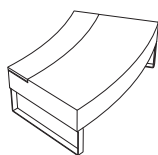

| Description | Dimensions (in) | (mm) | Dimensions (in) | (mm) |
|-------------------|-----------------|------|-----------------|----------------|
| Mixed wedge bench | Seat width | 56 | 1422 | Overall width |
| Radius = 78" | Seat depth | 21 | 533 | Overall depth |
| Degree = 30° | Seat height | 18 | 457 | Overall height |

| Model | Frame | Upholstery / List (\$) | Tablet finis |
|--------|--------|------------------------|-----------------------|
| HX7830 | E8 Std | Grade 1 1,989 | Specify laminate code |
| | E9 N/C | Grade 2 2,004 | |
| | | Grade 3 2,023 | |
| | | Grade 4 2,041 | |
| | | Grade 5 2,060 | |
| | | Grade 6 2,079 | |
| | | Grade 8 2,116 | |

H7830X

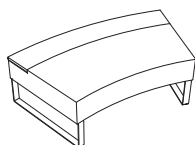

| Description | Dimensions (in) | (mm) | Dimensions (in) | (mm) |
|-------------------|-----------------|------|-----------------|----------------|
| Mixed wedge bench | Seat width | 51 | 1295 | Overall width |
| Radius = 78" | Seat depth | 21 | 533 | Overall depth |
| Degree = 30° | Seat height | 18 | 457 | Overall height |

| Model | Frame | Upholstery / List (\$) | Tablet finis |
|--------|--------|------------------------|-----------------------|
| H7830X | E8 Std | Grade 1 1,989 | Specify laminate code |
| | E9 N/C | Grade 2 2,004 | |
| | | Grade 3 2,023 | |
| | | Grade 4 2,041 | |
| | | Grade 5 2,060 | |
| | | Grade 6 2,079 | |
| | | Grade 8 2,116 | |

HC7830

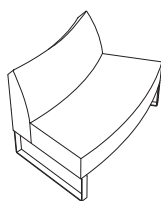

| Description | Dimensions (in) | (mm) | Dimensions (in) | (mm) |
|--------------|-----------------|------|-----------------|----------------|
| Wedge chair | Seat width | 56 | 1422 | Overall width |
| Radius = 78" | Seat depth | 21 | 533 | Overall depth |
| Degree = 30° | Seat height | 18 | 457 | Overall height |
| | Back height | 16 | 406 | |
| | Back width | 45 | 1143 | |

| Model | Frame | Upholstery / List (\$) |
|--------|--------|------------------------|
| HC7830 | E8 Std | Grade 1 2,427 |
| | E9 N/C | Grade 2 2,449 |
| | | Grade 3 2,477 |
| | | Grade 4 2,505 |
| | | Grade 5 2,533 |
| | | Grade 6 2,562 |
| | | Grade 8 2,618 |

H7830C

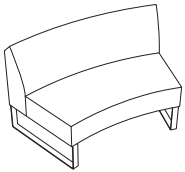

| Description | Dimensions | (in) | (mm) | Dimensions | (in) | (mm) |
|--------------|-------------|--------|------|----------------|--------|------|
| Wedge chair | Seat width | 51 1/2 | 1308 | Overall width | 56 | 1422 |
| Radius = 78" | Seat depth | 21 | 533 | Overall depth | 32 3/4 | 832 |
| Degree = 30° | Seat height | 18 | 457 | Overall height | 34 | 864 |
| | Back height | 16 | 406 | | | |
| | Back width | 51 1/2 | 1308 | | | |

| Model | Frame | Upholstery / List (\$) |
|--------|--------|------------------------|
| H7830C | E8 Std | Grade 1 2,427 |
| | | Grade 2 2,452 |
| | E9 N/C | Grade 3 2,483 |
| | | Grade 4 2,514 |
| | | Grade 5 2,545 |
| | | Grade 6 2,577 |
| | | Grade 7 2,608 |
| | | Grade 8 2,639 |

H7845

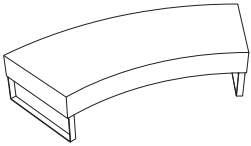

| Description | Dimensions | (in) | (mm) | Dimensions | (in) | (mm) |
|--------------|-------------|------|------|----------------|------|------|
| Wedge bench | Seat width | 83 | 2108 | Overall width | 83 | 2108 |
| Radius = 78" | Seat depth | 30 | 762 | Overall depth | 36 | 915 |
| Degree = 45° | Seat height | 18 | 457 | Overall height | 18 | 457 |

| Model | Frame | Upholstery / List (\$) |
|-------|--------|------------------------|
| H7845 | E8 Std | Grade 1 2,258 |
| | | Grade 2 2,275 |
| | E9 N/C | Grade 3 2,297 |
| | | Grade 4 2,319 |
| | | Grade 5 2,341 |
| | | Grade 6 2,363 |
| | | Grade 7 2,385 |
| | | Grade 8 2,407 |

HX7845

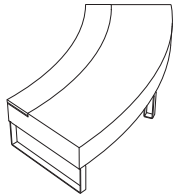

| Description | Dimensions | (in) | (mm) | Dimensions | (in) | (mm) |
|-------------------|-------------|------|------|----------------|------|------|
| Mixed wedge bench | Seat width | 83 | 2108 | Overall width | 83 | 2108 |
| Radius = 78" | Seat depth | 21 | 533 | Overall depth | 36 | 915 |
| Degree = 45° | Seat height | 18 | 457 | Overall height | 18 | 457 |

| Model | Frame | Upholstery / List (\$) | Tablet finis |
|--------|--------|------------------------|-----------------------|
| HX7845 | E8 Std | Grade 1 2,614 | Specify laminate code |
| | | Grade 2 2,632 | |
| | E9 N/C | Grade 3 2,654 | |
| | | Grade 4 2,675 | |
| | | Grade 5 2,697 | |
| | | Grade 6 2,719 | |
| | | Grade 7 2,741 | |
| | | Grade 8 2,763 | |

H7845X

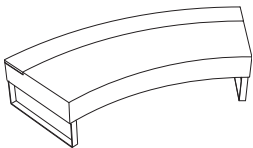

| Description | Dimensions | (in) | (mm) | Dimensions | (in) | (mm) |
|-------------------|-------------|------|------|----------------|------|------|
| Mixed wedge bench | Seat width | 83 | 2108 | Overall width | 83 | 2108 |
| Radius = 78" | Seat depth | 21 | 533 | Overall depth | 36 | 915 |
| Degree = 45° | Seat height | 18 | 457 | Overall height | 18 | 457 |

| Model | Frame | Upholstery / List (\$) | Tablet finis |
|--------|--------|------------------------|-----------------------|
| H7845X | E8 Std | Grade 1 2,614 | Specify laminate code |
| | | Grade 2 2,632 | |
| | E9 N/C | Grade 3 2,654 | |
| | | Grade 4 2,675 | |
| | | Grade 5 2,697 | |
| | | Grade 6 2,719 | |
| | | Grade 7 2,741 | |
| | | Grade 8 2,763 | |

HC7845

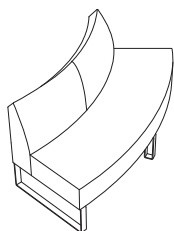

| Description | Dimensions (in) | (mm) | Dimensions (in) | (mm) | | |
|--------------|-----------------|------|-----------------|----------------|----|------|
| Wedge chair | Seat width | 83 | 2108 | Overall width | 83 | 2108 |
| Radius = 78" | Seat depth | 21 | 533 | Overall depth | 36 | 915 |
| Degree = 45° | Seat height | 18 | 457 | Overall height | 34 | 864 |
| | Back height | 16 | 406 | | | |
| | Back width | 67 | 1702 | | | |

| Model | Frame | Upholstery / List (\$) |
|--------|--------|------------------------|
| HC7845 | E8 Std | Grade 1 3,208 |
| | E9 N/C | Grade 2 3,243 |
| | | Grade 3 3,287 |
| | | Grade 4 3,331 |
| | | Grade 5 3,375 |
| | | Grade 6 3,418 |
| | | Grade 8 3,506 |

H7845C

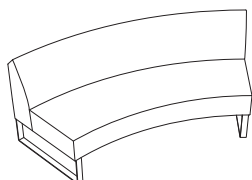

| Description | Dimensions (in) | (mm) | Dimensions (in) | (mm) | | |
|--------------|-----------------|------|-----------------|----------------|----|------|
| Wedge chair | Seat width | 76 | 1930 | Overall width | 83 | 2108 |
| Radius = 78" | Seat depth | 21 | 533 | Overall depth | 36 | 915 |
| Degree = 45° | Seat height | 18 | 457 | Overall height | 34 | 864 |
| | Back height | 16 | 406 | | | |
| | Back width | 76 | 1930 | | | |

| Model | Frame | Upholstery / List (\$) |
|--------|--------|------------------------|
| H7845C | E8 Std | Grade 1 3,208 |
| | E9 N/C | Grade 2 3,243 |
| | | Grade 3 3,287 |
| | | Grade 4 3,331 |
| | | Grade 5 3,375 |
| | | Grade 6 3,418 |
| | | Grade 8 3,506 |

HR24



| Description | Dimensions (in) | (mm) |
|---------------|-----------------|--------|
| Round ottoman | Overall width | 24 610 |
| | Overall depth | 24 610 |
| | Overall height | 18 457 |

| Model | Frame | Upholstery / List (\$) |
|-------|--------|------------------------|
| HR24 | E8 Std | Grade 1 907 |
| | E9 N/C | Grade 2 915 |
| | | Grade 3 925 |
| | | Grade 4 935 |
| | | Grade 5 945 |
| | | Grade 6 955 |
| | | Grade 8 975 |

HR36

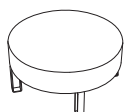

| Description | Dimensions (in) | (mm) |
|---------------|-----------------|--------|
| Round ottoman | Overall width | 36 914 |
| | Overall depth | 36 914 |
| | Overall height | 18 457 |

| Model | Frame | Upholstery / List (\$) |
|-------|--------|------------------------|
| HR36 | E8 Std | Grade 1 1,163 |
| | E9 N/C | Grade 2 1,176 |
| | | Grade 3 1,191 |
| | | Grade 4 1,207 |
| | | Grade 5 1,223 |
| | | Grade 6 1,238 |
| | | Grade 8 1,270 |

HR48

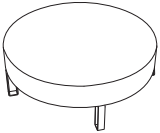

| Description | | Dimensions | (in) | (mm) |
|---------------|--|----------------|------|------|
| Round ottoman | | Overall width | 48 | 1219 |
| | | Overall depth | 48 | 1219 |
| | | Overall height | 18 | 457 |

| Model | Frame | Upholstery / List (\$) | |
|-------|--------|------------------------|-------|
| HR48 | E8 Std | Grade 1 | 1,614 |
| | | Grade 2 | 1,631 |
| | E9 N/C | Grade 3 | 1,653 |
| | | Grade 4 | 1,675 |
| | | Grade 5 | 1,697 |
| | | Grade 6 | 1,719 |
| | | Grade 7 | 1,741 |
| | | Grade 8 | 1,762 |

HRT24



| Description | | Dimensions | (in) | (mm) |
|-------------|--|-------------|------|------|
| Round table | | Seat width | 24 | 610 |
| | | Seat depth | 24 | 610 |
| | | Seat height | 18 | 457 |

| Model | Frame | Upholstery / List (\$) | | Laminate finis |
|-------|--------|------------------------|-------|----------------|
| HRT24 | E8 Std | Grade 1 | 1,063 | Specify code |
| | | Grade 2 | 1,069 | |
| | E9 N/C | Grade 3 | 1,077 | |
| | | Grade 4 | 1,084 | |
| | | Grade 5 | 1,092 | |
| | | Grade 6 | 1,099 | |
| | | Grade 7 | 1,106 | |
| | | Grade 8 | 1,114 | |

HRT36

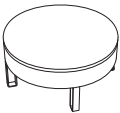

| Description | | Dimensions | (in) | (mm) |
|-------------|--|-------------|------|------|
| Round table | | Seat width | 36 | 915 |
| | | Seat depth | 36 | 915 |
| | | Seat height | 18 | 457 |

| Model | Frame | Upholstery / List (\$) | | Laminate finis |
|-------|--------|------------------------|-------|----------------|
| HRT36 | E8 Std | Grade 1 | 1,463 | Specify code |
| | | Grade 2 | 1,471 | |
| | E9 N/C | Grade 3 | 1,481 | |
| | | Grade 4 | 1,491 | |
| | | Grade 5 | 1,501 | |
| | | Grade 6 | 1,511 | |
| | | Grade 7 | 1,521 | |
| | | Grade 8 | 1,531 | |

HRT48

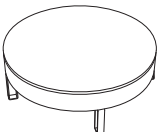

| Description | | Dimensions | (in) | (mm) |
|-------------|--|----------------|------|------|
| Round table | | Overall width | 48 | 1219 |
| | | Overall depth | 48 | 1219 |
| | | Overall height | 18 | 457 |

| Model | Frame | Upholstery / List (\$) | | Laminate finis |
|-------|--------|------------------------|-------|----------------|
| HRT48 | E8 Std | Grade 1 | 2,033 | Specify code |
| | | Grade 2 | 2,040 | |
| | E9 N/C | Grade 3 | 2,048 | |
| | | Grade 4 | 2,057 | |
| | | Grade 5 | 2,066 | |
| | | Grade 6 | 2,075 | |
| | | Grade 7 | 2,084 | |
| | | Grade 8 | 2,092 | |

HRTM36



| Description | Dimensions | (in) | (mm) |
|---------------------|-------------|------|------|
| Mixed table ottoman | Seat width | 36 | 915 |
| | Seat depth | 36 | 915 |
| | Seat height | 18 | 457 |

| Model | Frame | Upholstery / List (\$) | Laminate finis |
|--------|--------|------------------------|----------------|
| HRTM36 | E8 Std | Grade 1 1,420 | Specify code |
| | E9 N/C | Grade 2 1,428 | |
| | | Grade 3 1,439 | |
| | | Grade 4 1,450 | |
| | | Grade 5 1,461 | |
| | | Grade 6 1,472 | |
| | | Grade 8 1,494 | |

H RTP48

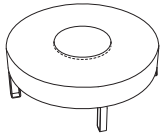

| Description | Dimensions | (in) | (mm) |
|---------------------|----------------|------|------|
| Mixed table ottoman | Overall width | 48 | 1219 |
| | Overall depth | 48 | 1219 |
| | Overall height | 18 | 457 |

| Model | Frame | Upholstery / List (\$) | Laminate finis |
|---------|--------|------------------------|----------------|
| H RTP48 | E8 Std | Grade 1 2,095 | Specify code |
| | E9 N/C | Grade 2 2,113 | |
| | | Grade 3 2,134 | |
| | | Grade 4 2,156 | |
| | | Grade 5 2,178 | |
| | | Grade 6 2,200 | |
| | | Grade 8 2,244 | |

HOT

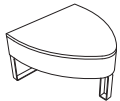

| Description | Dimensions | (in) | (mm) |
|-------------|-------------|------|------|
| Ogive table | Seat width | 30 | 762 |
| | Seat depth | 30 | 762 |
| | Seat height | 18 | 457 |

| Model | Frame | Upholstery / List (\$) | Laminate finis |
|-------|--------|------------------------|----------------|
| HOT | E8 Std | Grade 1 1,451 | Specify code |
| | E9 N/C | Grade 2 1,455 | |
| | | Grade 3 1,461 | |
| | | Grade 4 1,467 | |
| | | Grade 5 1,472 | |
| | | Grade 6 1,478 | |
| | | Grade 8 1,489 | |

HT30

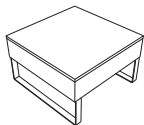

| Description | Dimensions | (in) | (mm) |
|--------------|-------------|------|------|
| Square table | Seat width | 30 | 762 |
| | Seat depth | 30 | 762 |
| | Seat height | 18 | 457 |

| Model | Frame | Upholstery / List (\$) | Laminate finis |
|-------|--------|------------------------|----------------|
| HT30 | E8 Std | Grade 1 1,207 | Specify code |
| | E9 N/C | Grade 2 1,212 | |
| | | Grade 3 1,217 | |
| | | Grade 4 1,223 | |
| | | Grade 5 1,228 | |
| | | Grade 6 1,234 | |
| | | Grade 8 1,245 | |

HT60

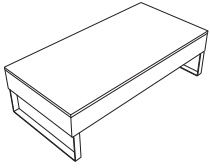

| Description | Dimensions | (in) | (mm) |
|-------------------|-------------|------|------|
| Rectangular table | Seat width | 60 | 1524 |
| | Seat depth | 30 | 762 |
| | Seat height | 18 | 457 |

| Model | Frame | Upholstery / List (\$) | Laminate finis |
|-------|--------|------------------------|----------------|
| HT60 | E8 Std | Grade 1 | 1,870 |
| | | Grade 2 | 1,881 |
| | E9 N/C | Grade 3 | 1,895 |
| | | Grade 4 | 1,908 |
| | | Grade 5 | 1,922 |
| | | Grade 6 | 1,936 |
| | | Grade 7 | 1,950 |
| | | Grade 8 | 1,964 |

HA

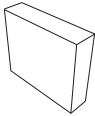

| Description | Dimensions | (in) | (mm) |
|-----------------|----------------|-------|------|
| Upholstered arm | Overall width | 7 1/2 | 191 |
| | Overall depth | 30 | 762 |
| | Overall height | 30 | 762 |

| Model | Upholstery / List (\$) | Other options (\$) |
|-------|------------------------|--------------------|
| HA | Grade 1 | 457 |
| | Grade 2 | 464 |
| | Grade 3 | 473 |
| | Grade 4 | 483 |
| | Grade 5 | 492 |
| | Grade 6 | 502 |
| | Grade 7 | 512 |
| | Grade 8 | 520 |

H-B153030

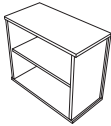

| Description | Dimensions | (in) | (mm) |
|-------------|----------------|------|------|
| Bookcase | Overall width | 15 | 381 |
| | Overall depth | 30 | 762 |
| | Overall height | 30 | 762 |

| Model | List (\$) | Laminate finis |
|-----------|-----------|----------------|
| H-B153030 | 663 | Specify code |

HIP HOP JUNIOR

HJ24

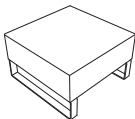

| Description | Dimensions | (in) | (mm) |
|--------------|----------------|------|------|
| Square bench | Overall width | 24 | 610 |
| | Overall depth | 24 | 610 |
| | Overall height | 14 | 356 |

| Model | Frame | Upholstery / List (\$) | |
|-------|--------|------------------------|-----|
| HJ24 | E8 Std | Grade 1 | 694 |
| | | Grade 2 | 699 |
| | E9 N/C | Grade 3 | 705 |
| | | Grade 4 | 712 |
| | | Grade 5 | 718 |
| | | Grade 6 | 724 |
| | | Grade 7 | 730 |
| | | Grade 8 | 737 |

HJC24

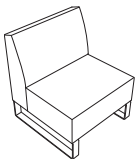

| Description | Dimensions | (in) | (mm) | Dimensions | (in) | (mm) |
|----------------|-------------|------|------|----------------|------|------|
| Straight chair | Seat width | 24 | 610 | Overall width | 24 | 610 |
| | Seat depth | 17 | 432 | Overall depth | 24 | 610 |
| | Seat height | 14 | 356 | Overall height | 28 | 711 |
| | Back height | 14 | 356 | | | |
| | Back width | 24 | 610 | | | |

| Model | Frame | Upholstery / List (\$) | |
|-------|--------|------------------------|-----|
| HJC24 | E8 Std | Grade 1 | 919 |
| | | Grade 2 | 924 |
| | E9 N/C | Grade 3 | 931 |
| | | Grade 4 | 937 |
| | | Grade 5 | 943 |
| | | Grade 6 | 949 |
| | | Grade 7 | 955 |
| | | Grade 8 | 962 |

HJ48

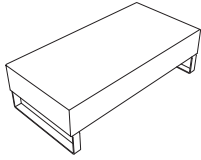

| Description | Dimensions | (in) | (mm) |
|-------------------|----------------|------|------|
| Rectangular bench | Overall width | 48 | 1219 |
| | Overall depth | 24 | 610 |
| | Overall height | 14 | 356 |

| Model | Frame | Upholstery / List (\$) |
|-------|--------|------------------------|
| HJ48 | E8 Std | Grade 1 1,144 |
| | | Grade 2 1,154 |
| | E9 N/C | Grade 3 1,167 |
| | | Grade 4 1,180 |
| | | Grade 5 1,192 |
| | | Grade 6 1,205 |
| | | Grade 8 1,230 |

HJC48

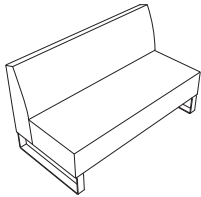

| Description | Dimensions | (in) | (mm) | Dimensions | (in) | (mm) |
|-------------|----------------|------|------|-------------|------|------|
| Loveseat | Overall width | 48 | 1219 | Seat width | 48 | 1219 |
| | Overall depth | 24 | 610 | Seat depth | 17 | 432 |
| | Overall height | 28 | 711 | Seat height | 14 | 356 |
| | Back height | 14 | 356 | | | |
| | Back width | 48 | 1219 | | | |

| Model | Frame | Upholstery / List (\$) |
|-------|--------|------------------------|
| HJC48 | E8 Std | Grade 1 1,595 |
| | | Grade 2 1,607 |
| | E9 N/C | Grade 3 1,623 |
| | | Grade 4 1,639 |
| | | Grade 5 1,654 |
| | | Grade 6 1,670 |
| | | Grade 8 1,701 |

HJ2445

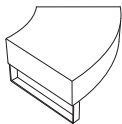

| Description | Dimensions | (in) | (mm) | Dimensions | (in) | (mm) |
|---|-------------|------|------|----------------|------|------|
| Wedge bench Radius = 24" Degree = 45° | Seat width | 41 | 1041 | Overall width | 41 | 1041 |
| | Seat depth | 24 | 610 | Overall depth | 31 ¾ | 806 |
| | Seat height | 14 | 356 | Overall height | 14 | 356 |
| | | | | | | |

| Model | Frame | Upholstery / List (\$) |
|--------|--------|------------------------|
| HJ2445 | E8 Std | Grade 1 1,119 |
| | | Grade 2 1,129 |
| | E9 N/C | Grade 3 1,142 |
| | | Grade 4 1,154 |
| | | Grade 5 1,167 |
| | | Grade 6 1,180 |
| | | Grade 8 1,205 |

HJ2445C

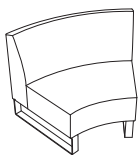

| Description | Dimensions | (in) | (mm) | Dimensions | (in) | (mm) |
|---|-------------|------|------|----------------|------|------|
| Wedge chair Radius = 24" Degree = 45° | Seat width | 32 | 813 | Overall width | 37 | 940 |
| | Seat depth | 17 | 432 | Overall depth | 26 | 661 |
| | Seat height | 14 | 356 | Overall height | 28 | 711 |
| | Back height | 14 | 356 | | | |
| | Back width | 34 ½ | 876 | | | |

| Model | Frame | Upholstery / List (\$) |
|---------|--------|------------------------|
| HJ2445C | E8 Std | Grade 1 1,395 |
| | | Grade 2 1,410 |
| | E9 N/C | Grade 3 1,428 |
| | | Grade 4 1,447 |
| | | Grade 5 1,466 |
| | | Grade 6 1,485 |
| | | Grade 8 1,522 |

HJC2445

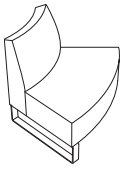

Description

Wedge chair
 Radius = 24"
 Degree = 45°

Dimensions

| | (in) | (mm) |
|-------------|--------|------|
| Seat width | 32 | 813 |
| Seat depth | 17 | 432 |
| Seat height | 14 | 356 |
| Back height | 14 | 356 |
| Back width | 25 1/4 | 641 |

Dimensions

| | (in) | (mm) |
|----------------|------|------|
| Overall width | 37 | 940 |
| Overall depth | 26 | 661 |
| Overall height | 28 | 711 |

| Model | Frame | Upholstery / List (\$) |
|---------|--------|------------------------|
| HJC2445 | E8 Std | Grade 1 1,395 |
| | E9 N/C | Grade 2 1,410 |
| | | Grade 3 1,428 |
| | | Grade 4 1,447 |
| | | Grade 5 1,466 |
| | | Grade 6 1,485 |
| | | Grade 8 1,522 |

HIP HOP – SOLUTIONS

HOP – S1

\$58,356

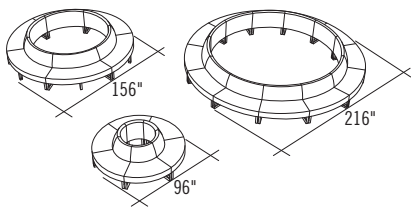

- 6 HC1860
- 6 HC4860
- 12 HC7830

HOP – S5

\$9,231

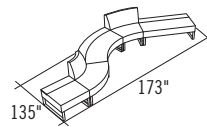

- 1 H30X
- 1 H60X
- 1 H1860X
- 1 HC1860
- 1 H4830C

HOP – S2

\$69,002

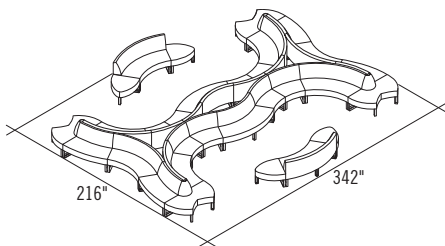

- 4 HO
- 4 HV
- 8 H4830C
- 8 H4860C
- 2 HC4860
- 4 H7830

HOP – S6

\$13,504

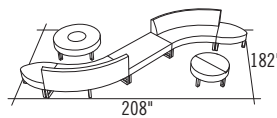

- 2 HO
- 1 H60
- 2 H4860C
- 1 H RTP48
- 1 H RTM36

HOP – S7

\$7,098

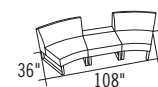

- 1 H30X
- 2 H4860C

HOP – S3

\$18,496

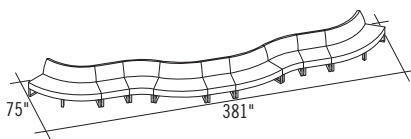

- 3 HC30
- 2 H4830C
- 2 H4860C
- 2 H7830

HOP – S8

\$13,020

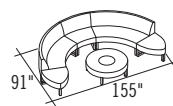

- 1 H4830C
- 2 H4860C
- 2 HO
- 1 H RTP48

HOP – S4

\$8,399

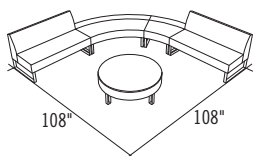

- 2 HC30
- 1 H4860X
- 1 H4830X
- 1 H RT36

HOP – S9

\$13,191

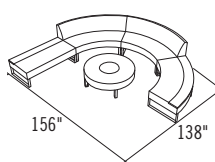

- 1 H60X
- 2 H4860C
- 1 H4860X
- 1 H RTP48

LOUNGE

SPECIFICATIONS

- All models ship assembled.
- Fabric/fabric, fabric/vinyl and vinyl/vinyl dual upholstery is available. The first upholstery code is the backrest and seat, the second upholstery code is for the arms.
- If dual upholstery combination is from two different grades, list price is the highest grade of the two.
- 5" height metal legs in aluminum finish.
- C.O.M./C.O.V.: please refer to page 54.

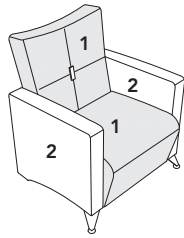

DUAL UPHOLSTERY APPLICATION

SAMPLE ORDER: LC1-ML-AM24-OL11-A



SAMPLE ORDER: LC1-ML-OL11-A

LC1



| Description | Dimensions | (in) | (mm) | Dimensions | (in) | (mm) |
|---------------------|-------------|------|------|----------------|------|------|
| Armchair | Seat width | 21 ½ | 546 | Overall width | 31 | 787 |
| Metal legs in front | Seat depth | 20 | 508 | Overall depth | 32 | 813 |
| | Seat height | 19 | 483 | Overall height | 34 | 864 |
| | Back height | 20 | 508 | | | |

| Model | Frame | Upholstery / List (\$) | Button (\$) |
|-------|--------|------------------------|-------------|
| LC1 | ML Std | Grade 1 | 1,682 |
| | | Grade 2 | 1,710 |
| | | Grade 3 | 1,744 |
| | | Grade 4 | 1,779 |
| | | Grade 5 | 1,813 |
| | | Grade 6 | 1,847 |
| | | Grade 7 | 2,945 |
| | | Grade 8 | 1,916 |
| | | | A Std |
| | | | SA N/C |

LOUNGE

SPECIFICATIONS

- All models ship assembled.
- Fabric/fabric, fabric/vinyl and vinyl/vinyl dual upholstery is available.
The first upholstery code is the backrest and arm structure, the second upholstery code is for the seat.
- If dual upholstery combination is from two different grades, list price is the highest grade of the two.
- Refer to page 59 for the 4 wood leg finishes available.
- C.O.M./C.O.V.: please refer to page 54.

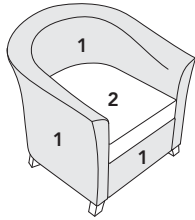

DUAL UPHOLSTERY APPLICATION

SAMPLE ORDER: MA1-W2-TN054-TN054

1 2

SAMPLE ORDER: MA1-W2-TN054-TN054

MA1

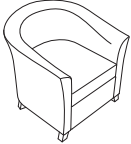

| Description | Dimensions | (in) | (mm) | Dimensions | (in) | (mm) |
|-------------|-------------|------|------|----------------|------|------|
| Armchair | Seat width | 20 ¼ | 514 | Overall width | 29 ½ | 750 |
| Wooden legs | Seat depth | 21 | 534 | Overall depth | 31 | 788 |
| | Seat height | 18 | 457 | Overall height | 31 ¾ | 807 |
| | Back height | 12 | 305 | | | |

| Model | Frame | Upholstery / List (\$) |
|-------|--------|------------------------|
| MA1 | W1 Std | Grade 1 1,926 |
| | W2 N/C | Grade 2 1,949 |
| | W3 N/C | Grade 3 1,978 |
| | W4 N/C | Grade 4 2,007 |
| | | Grade 5 2,036 |
| | | Grade 6 2,064 |
| | | Grade 7 2,991 |
| | | Grade 8 2,122 |



LOUNGE

SPECIFICATIONS

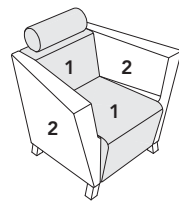
- All models ship assembled.
- Fabric/fabric, fabric/vinyl and vinyl/vinyl dual upholstery is available. The first upholstery code is the backrest and arm structure, the second upholstery code is for the seat.
- If dual upholstery combination is from two different grades, list price is the highest grade of the two.
- Headrest cannot be retrofitted on existing model.
- 16-gauge steel legs.
- C.O.M./C.O.V.: please refer to page 54.



DUAL UPHOLSTERY APPLICATION

SAMPLE ORDER: NA1-E9--

SAMPLE ORDER: NA1-E9-CE77-CE77

NA1

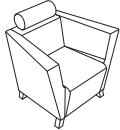

| Description | Dimensions | (in) | (mm) | Dimensions | (in) | (mm) |
|--------------|-------------|------|------|----------------|------|------|
| Armchair | Seat width | 21 | 533 | Overall width | 34 ¾ | 883 |
| Metal legs | Seat depth | 20 ¾ | 527 | Overall depth | 29 | 737 |
| 6"H headrest | Seat height | 17 ½ | 445 | Overall height | 33 ¾ | 857 |
| | Back height | 10 ½ | 267 | | | |

| Model | Frame | Upholstery / List (\$) | Other options (\$) |
|-------|--------|------------------------|--------------------|
| NA1 | E8 Std | Grade 1 2,026 | Grade 5 2,145 |
| | E9 N/C | Grade 2 2,051 | Grade 6 2,176 |
| | | Grade 3 2,083 | Grade 7 3,069 |
| | | Grade 4 2,114 | Grade 8 2,239 |

NA2

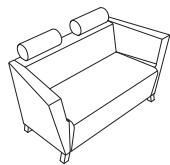

| Description | Dimensions | (in) | (mm) | Dimensions | (in) | (mm) |
|--------------|-------------|------|------|----------------|------|------|
| Loveseat | Seat width | 45 | 1143 | Overall width | 58 ¾ | 1492 |
| Metal legs | Seat depth | 20 ¾ | 527 | Overall depth | 29 | 737 |
| 6"H headrest | Seat height | 17 ½ | 445 | Overall height | 33 ¾ | 857 |
| | Back height | 10 ½ | 267 | | | |

| Model | Frame | Upholstery / List (\$) | Other options (\$) |
|-------|--------|------------------------|--------------------|
| NA2 | E8 Std | Grade 1 2,627 | Grade 5 2,841 |
| | E9 N/C | Grade 2 2,672 | Grade 6 2,897 |
| | | Grade 3 2,728 | Grade 7 4,493 |
| | | Grade 4 2,784 | Grade 8 3,009 |

NA3

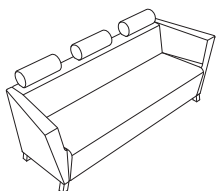

| Description | Dimensions | (in) | (mm) | Dimensions | (in) | (mm) |
|--------------|-------------|------|------|----------------|------|------|
| Sofa | Seat width | 69 | 1753 | Overall width | 82 ¾ | 2102 |
| Metal legs | Seat depth | 20 ¾ | 527 | Overall depth | 29 | 737 |
| 6"H headrest | Seat height | 17 ½ | 445 | Overall height | 33 ¾ | 857 |
| | Back height | 10 ½ | 267 | | | |

| Model | Frame | Upholstery / List (\$) | Other options (\$) |
|-------|--------|------------------------|--------------------|
| NA3 | E8 Std | Grade 1 3,152 | Grade 5 3,485 |
| | E9 N/C | Grade 2 3,222 | Grade 6 3,572 |
| | | Grade 3 3,310 | Grade 7 6,050 |
| | | Grade 4 3,397 | Grade 8 3,747 |

LOUNGE

SPECIFICATIONS

- All models ship assembled.
- Fabric/fabric, fabric/vinyl and vinyl/vinyl dual upholstery is available. The first upholstery code is for the seat, the second upholstery code is for the arms and structure.
- If dual upholstery combination is from two different grades, list price is the highest grade of the two.
- 14-gauge steel belt with 16-gauge legs.
- Please refer to your Lacasse Sampler for laminate choices for the Oly bench with storage LY2B and with shelf LY2T.
- C.O.M./C.O.V.: please refer to page 54.

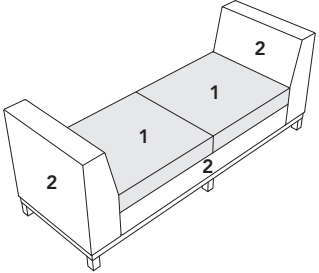

DUAL UPHOLSTERY APPLICATION

SAMPLE ORDER: LY2B-E8-SL24-GR909-TWT

SL24
1

GR909
2

SAMPLE ORDER: LY2B-E8-SL24-GR909-TWT

LY1

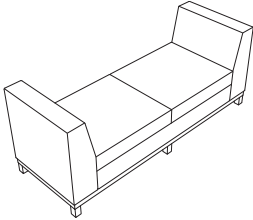

| Description | Dimensions | (in) | (mm) | Dimensions | (in) | (mm) |
|-------------|-------------|------|------|----------------|------|------|
| Bench | Seat width | 55 | 1397 | Overall width | 74 | 1880 |
| | Seat depth | 25 | 635 | Overall depth | 25 | 635 |
| | Seat height | 18 | 457 | Overall height | 31 ½ | 800 |
| | Back height | 13 ½ | 343 | | | |

| Model | Frame | Upholstery / List (\$) | | | |
|-------|--------|------------------------|---------|-------|--|
| LY1 | E8 Std | Grade 1 2,158 | Grade 5 | 2,312 | |
| | E9 N/C | Grade 2 2,190 | Grade 6 | 2,353 | |
| | | Grade 3 2,231 | Grade 7 | 3,508 | |
| | | Grade 4 2,271 | Grade 8 | 2,434 | |

LY2T

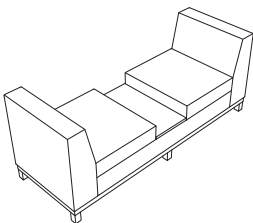

| Description | Dimensions | (in) | (mm) | Dimensions | (in) | (mm) |
|-----------------------------|-------------|------|------|----------------|------|------|
| Bench with integrated table | Seat width | 55 | 1397 | Overall width | 74 | 1880 |
| | Seat depth | 25 | 635 | Overall depth | 25 | 635 |
| | Seat height | 18 | 457 | Overall height | 31 ½ | 800 |
| | Back height | 13 ½ | 343 | | | |

| Model | Frame | Upholstery / List (\$) | | Laminate finis | |
|-------|--------|------------------------|---------|----------------|--------------|
| LY2T | E8 Std | Grade 1 2,264 | Grade 5 | 2,418 | Specify code |
| | E9 N/C | Grade 2 2,296 | Grade 6 | 2,459 | |
| | | Grade 3 2,337 | Grade 7 | 3,493 | |
| | | Grade 4 2,378 | Grade 8 | 2,540 | |

LY2B

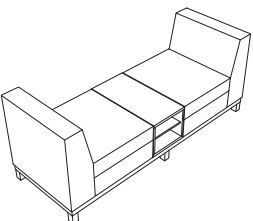

| Description | Dimensions | (in) | (mm) | Dimensions | (in) | (mm) |
|--------------------------------|-------------|------|------|----------------|------|------|
| Bench with integrated bookcase | Seat width | 20 ½ | 521 | Overall width | 74 | 1880 |
| | Seat depth | 25 | 635 | Overall depth | 25 | 635 |
| | Seat height | 18 | 457 | Overall height | 31 ½ | 800 |
| | Back height | 13 ½ | 343 | | | |

| Model | Frame | Upholstery / List (\$) | | Laminate finis | |
|-------|--------|------------------------|---------|----------------|--------------|
| LY2B | E8 Std | Grade 1 2,364 | Grade 5 | 2,518 | Specify code |
| | E9 N/C | Grade 2 2,397 | Grade 6 | 2,559 | |
| | | Grade 3 2,437 | Grade 7 | 3,593 | |
| | | Grade 4 2,478 | Grade 8 | 2,640 | |

LOUNGE

SPECIFICATIONS

- All models ship assembled.
- Available in one-tone only.
- 4 ½" metal legs in aluminum finish for PF4, PF5 & PF6.
- C.O.M./C.O.V.: please refer to page 54.

SAMPLE ORDER: PF1-CY07

PF1



| Description | Dimensions | (in) | (mm) |
|---------------|----------------|------|------|
| Round ottoman | Overall width | 18 | 457 |
| | Overall depth | 18 | 457 |
| | Overall height | 17 ¼ | 438 |

| Model | Upholstery / List (\$) | |
|-------|------------------------|-----|
| PF1 | Grade 1 | 488 |
| | Grade 2 | 495 |
| | Grade 3 | 505 |
| | Grade 4 | 514 |
| | Grade 5 | 523 |
| | Grade 6 | 533 |
| | Grade 7 | 674 |
| | Grade 8 | 552 |

PF2

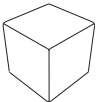

| Description | Dimensions | (in) | (mm) |
|----------------|----------------|------|------|
| Square ottoman | Overall width | 18 | 457 |
| | Overall depth | 18 | 457 |
| | Overall height | 17 ¼ | 438 |

| Model | Upholstery / List (\$) | |
|-------|------------------------|-----|
| PF2 | Grade 1 | 513 |
| | Grade 2 | 522 |
| | Grade 3 | 533 |
| | Grade 4 | 543 |
| | Grade 5 | 554 |
| | Grade 6 | 565 |
| | Grade 7 | 798 |
| | Grade 8 | 587 |

PF3

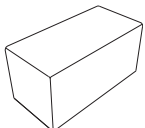

| Description | Dimensions | (in) | (mm) |
|---------------------|----------------|------|------|
| Rectangular ottoman | Overall width | 36 | 915 |
| | Overall depth | 18 | 457 |
| | Overall height | 17 ¼ | 438 |

| Model | Upholstery / List (\$) | |
|-------|------------------------|-------|
| PF3 | Grade 1 | 644 |
| | Grade 2 | 657 |
| | Grade 3 | 672 |
| | Grade 4 | 688 |
| | Grade 5 | 704 |
| | Grade 6 | 719 |
| | Grade 7 | 1,061 |
| | Grade 8 | 750 |

PF4



| Description | Dimensions | (in) | (mm) |
|---------------|----------------|------|------|
| Round ottoman | Overall width | 18 | 457 |
| Aluminum legs | Overall depth | 18 | 457 |
| | Overall height | 17 ¼ | 438 |

| Model | Frame | Upholstery / List (\$) |
|-------|--------|------------------------|
| PF4 | ML Std | Grade 1 525 |
| | | Grade 2 533 |
| | | Grade 3 542 |
| | | Grade 4 552 |
| | | Grade 5 561 |
| | | Grade 6 570 |
| | | Grade 7 712 |
| | | Grade 8 589 |

PF5

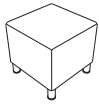

| Description | Dimensions | (in) | (mm) |
|----------------|----------------|------|------|
| Square ottoman | Overall width | 18 | 457 |
| Aluminum legs | Overall depth | 18 | 457 |
| | Overall height | 17 ¼ | 438 |

| Model | Frame | Upholstery / List (\$) |
|-------|--------|------------------------|
| PF5 | ML Std | Grade 1 550 |
| | | Grade 2 559 |
| | | Grade 3 570 |
| | | Grade 4 581 |
| | | Grade 5 592 |
| | | Grade 6 603 |
| | | Grade 7 836 |
| | | Grade 8 625 |

PF6

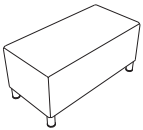

| Description | Dimensions | (in) | (mm) |
|---------------------|----------------|------|------|
| Rectangular ottoman | Overall width | 36 | 915 |
| Aluminum legs | Overall depth | 18 | 457 |
| | Overall height | 17 ¼ | 438 |

| Model | Frame | Upholstery / List (\$) |
|-------|--------|------------------------|
| PF6 | ML Std | Grade 1 682 |
| | | Grade 2 694 |
| | | Grade 3 710 |
| | | Grade 4 725 |
| | | Grade 5 741 |
| | | Grade 6 757 |
| | | Grade 7 1,099 |
| | | Grade 8 788 |

LOUNGE

SPECIFICATIONS

- All models ship assembled.
- Available in one-tone only.
- Refer to page 59 for the 4 wood leg finishes available.
- C.O.M./C.O.V.: please refer to page 54.

SAMPLE ORDER: SH3-W4-TN808

SH1

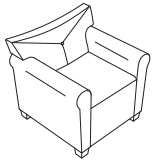

| Description | Dimensions | (in) | (mm) | Dimensions | (in) | (mm) |
|-------------|-------------|------|------|----------------|------|------|
| Armchair | Seat width | 23 | 533 | Overall width | 34 ½ | 876 |
| Wooden legs | Seat depth | 20 ½ | 584 | Overall depth | 30 ½ | 775 |
| | Seat height | 18 | 457 | Overall height | 31 | 787 |
| | Back height | 13 | 330 | | | |

| Model | Frame | Upholstery / List (\$) | |
|-------|--------|------------------------|-------|
| SH1 | W1 Std | Grade 1 | 1,795 |
| | | Grade 2 | 1,822 |
| | | Grade 3 | 1,857 |
| | | Grade 4 | 1,891 |
| | | Grade 5 | 1,926 |
| | | Grade 6 | 1,960 |
| | | Grade 7 | 2,936 |
| | | Grade 8 | 2,029 |

SH2

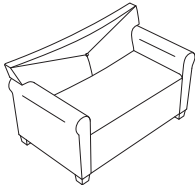

| Description | Dimensions | (in) | (mm) | Dimensions | (in) | (mm) |
|-------------|-------------|------|------|----------------|------|------|
| Loveseat | Seat width | 44 | 1118 | Overall width | 55 | 1397 |
| Wooden legs | Seat depth | 20 ½ | 584 | Overall depth | 30 ½ | 775 |
| | Seat height | 18 | 457 | Overall height | 31 | 787 |
| | Back height | 13 | 330 | | | |

| Model | Frame | Upholstery / List (\$) | |
|-------|--------|------------------------|-------|
| SH2 | W1 Std | Grade 1 | 2,333 |
| | | Grade 2 | 2,383 |
| | | Grade 3 | 2,445 |
| | | Grade 4 | 2,508 |
| | | Grade 5 | 2,570 |
| | | Grade 6 | 2,633 |
| | | Grade 7 | 4,407 |
| | | Grade 8 | 2,758 |

SH3

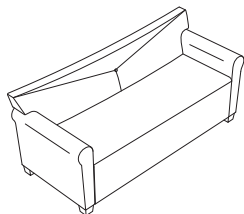

| Description | Dimensions | (in) | (mm) | Dimensions | (in) | (mm) |
|-------------|-------------|------|------|----------------|------|------|
| Sofa | Seat width | 66 | 1676 | Overall width | 77 | 1956 |
| Wooden legs | Seat depth | 20 ½ | 584 | Overall depth | 30 ½ | 775 |
| | Seat height | 18 | 457 | Overall height | 31 | 787 |
| | Back height | 13 | 330 | | | |

| Model | Frame | Upholstery / List (\$) | |
|-------|--------|------------------------|-------|
| SH3 | W1 Std | Grade 1 | 2,796 |
| | | Grade 2 | 2,868 |
| | | Grade 3 | 2,959 |
| | | Grade 4 | 3,049 |
| | | Grade 5 | 3,140 |
| | | Grade 6 | 3,231 |
| | | Grade 7 | 5,803 |
| | | Grade 8 | 3,412 |

LOUNGE

SPECIFICATIONS

- All models ship assembled.
- Fabric/fabric, fabric/vinyl and vinyl/vinyl dual upholstery is available. The first upholstery code is the backrest and arm structure, the second upholstery code is for the seat.
- If dual upholstery combination is from two different grades, list price is the highest grade of the two.
- Headrest cannot be retrofitted on existing model.
- 16-gauge steel legs.
- C.O.M./C.O.V.: please refer to page 54.

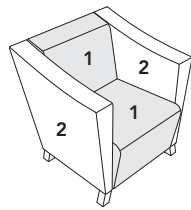

DUAL UPHOLSTERY APPLICATION

SAMPLE ORDER: SO2-E8-**WH03**-**WH03**

① ②

SAMPLE ORDER: SO2-E8-WH03-WH03

S01

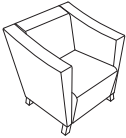

| Description | Dimensions (in) | (mm) | Dimensions (in) | (mm) |
|-------------|-----------------|------|-----------------|------|
| Armchair | Seat width | 21 | 30 ¾ | 781 |
| Metal legs | Seat depth | 20 ¾ | 30 ½ | 775 |
| | Seat height | 17 ½ | 31 ¾ | 807 |
| | Back height | 14 ¼ | | |

| Model | Frame | Upholstery / List (\$) | Other options (\$) |
|-------|--------|------------------------|--------------------|
| S01 | E8 Std | Grade 1 1,814 | HR 125 |
| | E9 N/C | Grade 2 1,839 | |
| | | Grade 3 1,870 | |
| | | Grade 4 1,901 | |
| | | Grade 5 1,932 | |
| | | Grade 6 1,964 | |
| | | Grade 7 2,845 | |
| | | Grade 8 2,026 | |

S02

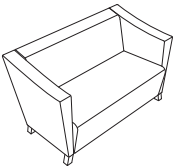

| Description | Dimensions (in) | (mm) | Dimensions (in) | (mm) |
|-------------|-----------------|------|-----------------|------|
| Loveseat | Seat width | 45 | 54 ¾ | 1391 |
| Metal legs | Seat depth | 20 ¾ | 30 ½ | 775 |
| | Seat height | 17 ½ | 31 ¾ | 807 |
| | Back height | 14 ¼ | | |

| Model | Frame | Upholstery / List (\$) | Other options (\$) |
|-------|--------|------------------------|--------------------|
| S02 | E8 Std | Grade 1 2,364 | HR 250 |
| | E9 N/C | Grade 2 2,407 | |
| | | Grade 3 2,460 | |
| | | Grade 4 2,513 | |
| | | Grade 5 2,566 | |
| | | Grade 6 2,619 | |
| | | Grade 7 4,120 | |
| | | Grade 8 2,725 | |

S03

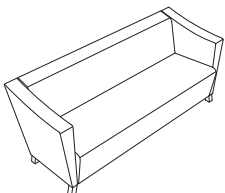

| Description | Dimensions (in) | (mm) | Dimensions (in) | (mm) |
|-------------|-----------------|------|-----------------|------|
| Sofa | Seat width | 69 | 78 ¾ | 2000 |
| Metal legs | Seat depth | 20 ¾ | 30 ½ | 775 |
| | Seat height | 17 ½ | 31 ¾ | 807 |
| | Back height | 14 ¼ | | |

| Model | Frame | Upholstery / List (\$) | Other options (\$) |
|-------|--------|------------------------|--------------------|
| S03 | E8 Std | Grade 1 2,958 | HR 375 |
| | E9 N/C | Grade 2 3,018 | |
| | | Grade 3 3,093 | |
| | | Grade 4 3,168 | |
| | | Grade 5 3,243 | |
| | | Grade 6 3,318 | |
| | | Grade 7 5,450 | |
| | | Grade 8 3,468 | |

PUBLIC AREAS AND HEALTHCARE

SPECIFICATIONS

- All models ship assembled.
- Fabric/fabric, fabric/vinyl and vinyl/vinyl dual upholstery is available. The first upholstery code is the backrest and seat cushion, the second upholstery code is for the arms.
- If dual upholstery combination is from two different grades, list price is the highest grade of the two.
- 1" gap around seat cushion for ease of cleaning.
- 16-gauge steel base and belt.
- Levelers allow up to ¾" height adjustment.
- Please refer to your Lacasse Sampler for laminate choices.
- Please refer to accessories on page 53 for ganging brackets and floor anchors.
- C.O.M./C.O.V.: please refer to page 54.

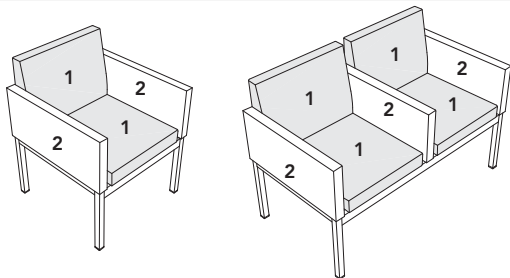

DUAL UPHOLSTERY APPLICATION

SAMPLE ORDER: TE2TR-E9-MG050-SL06-TWT

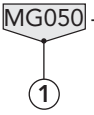

1

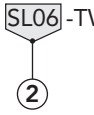

2

SAMPLE ORDER: TE2TR-E9-MG050-SL06-TWT

TE1

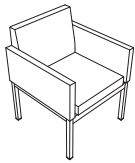

| Description | Dimensions (in) | (mm) | Dimensions (in) | (mm) | | |
|-------------|-----------------|------|-----------------|----------------|------|-----|
| Armchair | Seat width | 20 ½ | 521 | Overall width | 24 ½ | 622 |
| | Seat depth | 20 | 508 | Overall depth | 24 ½ | 622 |
| | Seat height | 18 | 457 | Overall height | 31 | 787 |
| | Back height | 13 | 330 | | | |

| Model | Frame | Upholstery / List (\$) | |
|-------|--------|------------------------|-------|
| TE1 | E8 Std | Grade 1 | 1,157 |
| | | Grade 2 | 1,173 |
| | E9 N/C | Grade 3 | 1,193 |
| | | Grade 4 | 1,213 |
| | | Grade 5 | 1,233 |
| | | Grade 6 | 1,253 |
| | | Grade 7 | 1,816 |
| | | Grade 8 | 1,293 |

TE2

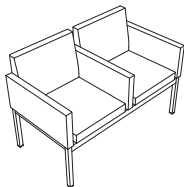

| Description | Dimensions (in) | (mm) | Dimensions (in) | (mm) | | |
|-----------------|-----------------|------|-----------------|----------------|------|------|
| 2-seat armchair | Seat width | 20 ½ | 521 | Overall width | 47 | 1194 |
| | Seat depth | 20 | 508 | Overall depth | 24 ½ | 622 |
| | Seat height | 18 | 457 | Overall height | 31 | 787 |
| | Back height | 13 | 330 | | | |

| Model | Frame | Upholstery / List (\$) | |
|-------|--------|------------------------|-------|
| TE2 | E8 Std | Grade 1 | 1,864 |
| | | Grade 2 | 1,891 |
| | E9 N/C | Grade 3 | 1,926 |
| | | Grade 4 | 1,960 |
| | | Grade 5 | 1,994 |
| | | Grade 6 | 2,029 |
| | | Grade 7 | 3,005 |
| | | Grade 8 | 2,098 |

TE2A

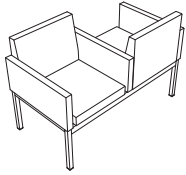

| Description | Dimensions | (in) | (mm) | Dimensions | (in) | (mm) |
|------------------------------|-------------|------|------|----------------|------|------|
| 2-seat armchair, alternating | Seat width | 20 ½ | 521 | Overall width | 47 | 1194 |
| | Seat depth | 20 | 508 | Overall depth | 24 ½ | 622 |
| | Seat height | 18 | 457 | Overall height | 31 | 787 |
| | Back height | 13 | 330 | | | |

| Model | Frame | Upholstery / List (\$) |
|-------|--------|------------------------|
| TE2A | E8 Std | Grade 1 1,864 |
| | | Grade 2 1,891 |
| | E9 N/C | Grade 3 1,926 |
| | | Grade 4 1,960 |
| | | Grade 5 1,994 |
| | | Grade 6 2,029 |
| | | Grade 7 3,005 |
| | | Grade 8 2,098 |

TE1TR

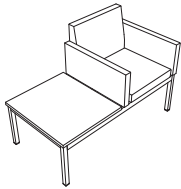

| Description | Dimensions | (in) | (mm) | Dimensions | (in) | (mm) |
|----------------------------|-------------|------|------|----------------|------|------|
| Armchair, right-side table | Seat width | 20 ½ | 521 | Overall width | 47 | 1194 |
| | Seat depth | 20 | 508 | Overall depth | 24 ½ | 622 |
| | Seat height | 18 | 457 | Overall height | 31 | 787 |
| | Back height | 13 | 330 | | | |

| Model | Frame | Upholstery / List (\$) | Table finis |
|-------|--------|------------------------|-----------------------|
| TE1TR | E8 Std | Grade 1 1,388 | Specify laminate code |
| | | Grade 2 1,404 | |
| | E9 N/C | Grade 3 1,424 | |
| | | Grade 4 1,444 | |
| | | Grade 5 1,464 | |
| | | Grade 6 1,484 | |
| | | Grade 7 2,047 | |
| | | Grade 8 1,524 | |

TE1TL

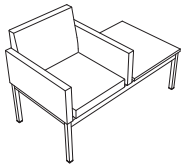

| Description | Dimensions | (in) | (mm) | Dimensions | (in) | (mm) |
|---------------------------|-------------|------|------|----------------|------|------|
| Armchair, left-side table | Seat width | 20 ½ | 521 | Overall width | 47 | 1194 |
| | Seat depth | 20 | 508 | Overall depth | 24 ½ | 622 |
| | Seat height | 18 | 457 | Overall height | 31 | 787 |
| | Back height | 13 | 330 | | | |

| Model | Frame | Upholstery / List (\$) | Table finis |
|-------|--------|------------------------|-----------------------|
| TE1TL | E8 Std | Grade 1 1,388 | Specify laminate code |
| | | Grade 2 1,404 | |
| | E9 N/C | Grade 3 1,424 | |
| | | Grade 4 1,444 | |
| | | Grade 5 1,464 | |
| | | Grade 6 1,484 | |
| | | Grade 7 2,047 | |
| | | Grade 8 1,524 | |

TE3

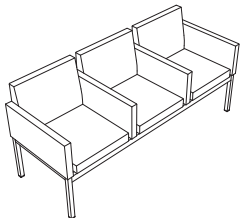

| Description | Dimensions | (in) | (mm) | Dimensions | (in) | (mm) |
|-----------------|-------------|------|------|----------------|------|------|
| 3-seat armchair | Seat width | 20 ½ | 521 | Overall width | 69 ½ | 1765 |
| | Seat depth | 20 | 508 | Overall depth | 24 ½ | 622 |
| | Seat height | 18 | 457 | Overall height | 31 | 787 |
| | Back height | 13 | 330 | | | |

| Model | Frame | Upholstery / List (\$) |
|-------|--------|------------------------|
| TE3 | E8 Std | Grade 1 2,433 |
| | | Grade 2 2,474 |
| | E9 N/C | Grade 3 2,525 |
| | | Grade 4 2,576 |
| | | Grade 5 2,628 |
| | | Grade 6 2,679 |
| | | Grade 7 4,134 |
| | | Grade 8 2,782 |

TE3A

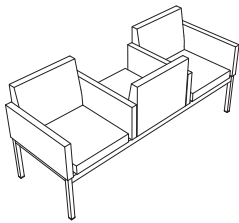

| Description | Dimensions (in) | (mm) | Dimensions (in) | (mm) | | |
|------------------------------|-----------------|------|-----------------|----------------|------|------|
| 3-seat armchair, alternating | Seat width | 20 ½ | 521 | Overall width | 69 ½ | 1765 |
| | Seat depth | 20 | 508 | Overall depth | 24 ½ | 622 |
| | Seat height | 18 | 457 | Overall height | 31 | 787 |
| | Back height | 13 | 330 | | | |

| Model | Frame | Upholstery / List (\$) | |
|-------|--------|------------------------|-------|
| TE3A | E8 Std | Grade 1 | 2,433 |
| | | Grade 2 | 2,474 |
| | E9 N/C | Grade 3 | 2,525 |
| | | Grade 4 | 2,576 |
| | | Grade 5 | 2,628 |
| | | Grade 6 | 2,679 |
| | | Grade 7 | 4,134 |
| | | Grade 8 | 2,782 |

TE2TR

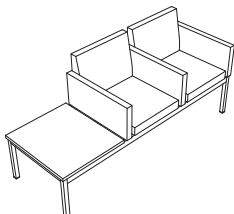

| Description | Dimensions (in) | (mm) | Dimensions (in) | (mm) | | |
|-----------------------------------|-----------------|------|-----------------|----------------|------|------|
| 2-seat armchair, right-side table | Seat width | 20 ½ | 521 | Overall width | 69 ½ | 1765 |
| | Seat depth | 20 | 508 | Overall depth | 24 ½ | 622 |
| | Seat height | 18 | 457 | Overall height | 31 | 787 |
| | Back height | 13 | 330 | | | |

| Model | Frame | Upholstery / List (\$) | Table finis |
|-------|--------|------------------------|-------------|
| TE2TR | E8 Std | Grade 1 | 2,151 |
| | | Grade 2 | 2,179 |
| | E9 N/C | Grade 3 | 2,213 |
| | | Grade 4 | 2,248 |
| | | Grade 5 | 2,282 |
| | | Grade 6 | 2,316 |
| | | Grade 7 | 3,293 |
| | | Grade 8 | 2,385 |

TE2TL

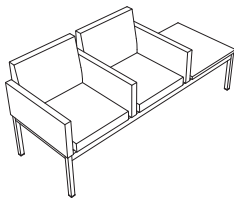

| Description | Dimensions (in) | (mm) | Dimensions (in) | (mm) | | |
|----------------------------------|-----------------|------|-----------------|----------------|------|------|
| 2-seat armchair, left-side table | Seat width | 20 ½ | 521 | Overall width | 69 ½ | 1765 |
| | Seat depth | 20 | 508 | Overall depth | 24 ½ | 622 |
| | Seat height | 18 | 457 | Overall height | 31 | 787 |
| | Back height | 13 | 330 | | | |

| Model | Frame | Upholstery / List (\$) | Table finis |
|-------|--------|------------------------|-------------|
| TE2TL | E8 Std | Grade 1 | 2,151 |
| | | Grade 2 | 2,179 |
| | E9 N/C | Grade 3 | 2,213 |
| | | Grade 4 | 2,248 |
| | | Grade 5 | 2,282 |
| | | Grade 6 | 2,316 |
| | | Grade 7 | 3,293 |
| | | Grade 8 | 2,385 |

TE2TC

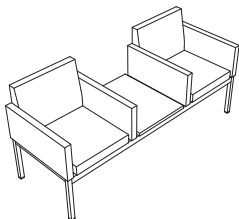

| Description | Dimensions (in) | (mm) | Dimensions (in) | (mm) | | |
|--------------------------------|-----------------|------|-----------------|----------------|------|------|
| 2-seat armchair, central table | Seat width | 20 ½ | 521 | Overall width | 69 ½ | 1765 |
| | Seat depth | 20 | 508 | Overall depth | 24 ½ | 622 |
| | Seat height | 18 | 457 | Overall height | 31 | 787 |
| | Back height | 13 | 330 | | | |

| Model | Frame | Upholstery / List (\$) | Table finis |
|-------|--------|------------------------|-------------|
| TE2TC | E8 Std | Grade 1 | 2,151 |
| | | Grade 2 | 2,179 |
| | E9 N/C | Grade 3 | 2,213 |
| | | Grade 4 | 2,248 |
| | | Grade 5 | 2,282 |
| | | Grade 6 | 2,316 |
| | | Grade 7 | 3,293 |
| | | Grade 8 | 2,385 |

TE01

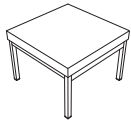

| Description | Dimensions | (in) | (mm) |
|-------------|----------------|------|------|
| Ottoman | Overall width | 24 ½ | 622 |
| | Overall depth | 24 ½ | 622 |
| | Overall height | 18 | 457 |

| Model | Frame | Upholstery / List (\$) |
|-------|--------|------------------------|
| TE01 | E8 Std | Grade 1 619 |
| | | Grade 2 623 |
| | E9 N/C | Grade 3 628 |
| | | Grade 4 632 |
| | | Grade 5 637 |
| | | Grade 6 642 |
| | | Grade 7 729 |
| | | Grade 8 651 |

TE02

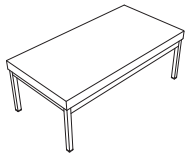

| Description | Dimensions | (in) | (mm) |
|----------------|----------------|------|------|
| 2-seat ottoman | Overall width | 47 | 1194 |
| | Overall depth | 24 ½ | 622 |
| | Overall height | 18 | 457 |

| Model | Frame | Upholstery / List (\$) |
|-------|--------|------------------------|
| TE02 | E8 Std | Grade 1 944 |
| | | Grade 2 962 |
| | E9 N/C | Grade 3 984 |
| | | Grade 4 1,006 |
| | | Grade 5 1,028 |
| | | Grade 6 1,049 |
| | | Grade 7 1,164 |
| | | Grade 8 1,093 |

TE03

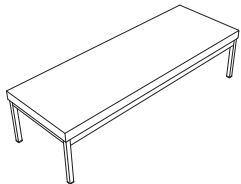

| Description | Dimensions | (in) | (mm) |
|----------------|----------------|------|------|
| 3-seat ottoman | Overall width | 69 ½ | 1765 |
| | Overall depth | 24 ½ | 622 |
| | Overall height | 18 | 457 |

| Model | Frame | Upholstery / List (\$) |
|-------|--------|------------------------|
| TE03 | E8 Std | Grade 1 1,245 |
| | | Grade 2 1,271 |
| | E9 N/C | Grade 3 1,304 |
| | | Grade 4 1,336 |
| | | Grade 5 1,369 |
| | | Grade 6 1,402 |
| | | Grade 7 1,574 |
| | | Grade 8 1,468 |

TE-T2424

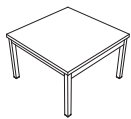

| Description | Dimensions | (in) | (mm) |
|--------------|----------------|------|------|
| Square table | Overall width | 24 ½ | 622 |
| | Overall depth | 24 ½ | 622 |
| | Overall height | 15 ½ | 394 |

| Model | Frame | List (\$) | Table finis |
|----------|--------|-----------|--------------|
| TE-T2424 | E8 Std | 657 | Specify code |
| | E9 N/C | | |

TE-T2448

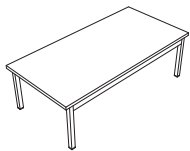

| Description | Dimensions | (in) | (mm) |
|-------------------|----------------|------|------|
| Rectangular table | Overall width | 47 | 1194 |
| | Overall depth | 24 ½ | 622 |
| | Overall height | 15 ½ | 394 |

| Model | Frame | List (\$) | Table finis |
|----------|--------|-----------|-----------------------|
| TE-T2448 | E8 Std | 857 | Specify laminate code |
| | E9 N/C | | |

Available solutions for Terra are the same as for Zeta. See page 52 for details.

PUBLIC AREAS

SPECIFICATIONS

- All models ship assembled.
- Fabric/fabric, fabric/vinyl and vinyl/vinyl dual upholstery is available. The first upholstery code is the backrest and seat cushion, the second upholstery code is for the arms.
- If dual upholstery combination is from two different grades, list price is the highest grade of the two.
- 16-gauge steel base and belt.
- Levelers allow up to ¾" height adjustment.
- Please refer to your Lacasse Sampler for laminate choices.
- Please refer to accessories on page 53 for ganging brackets and floor anchors.
- C.O.M./C.O.V.: please refer to page 54.

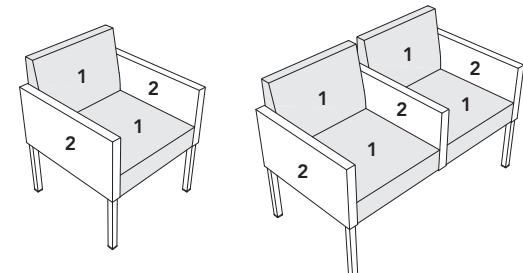

DUAL UPHOLSTERY APPLICATION

SAMPLE ORDER: ZE1-E8-AM24-AM47

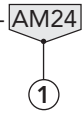

1



2

SAMPLE ORDER: ZE1-E8-AM24-AM47

ZE1

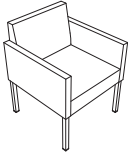

| Description | Dimensions | (in) | (mm) | Dimensions | (in) | (mm) |
|-------------|-------------|------|------|----------------|------|------|
| Armchair | Seat width | 20 ½ | 521 | Overall width | 24 ½ | 622 |
| | Seat depth | 20 | 508 | Overall depth | 24 ½ | 622 |
| | Seat height | 18 | 457 | Overall height | 31 | 787 |
| | Back height | 13 | 330 | | | |

| Model | Frame | Upholstery / List (\$) |
|-------|--------|------------------------|
| ZE1 | E8 Std | Grade 1 1,157 |
| | | Grade 2 1,173 |
| | E9 N/C | Grade 3 1,193 |
| | | Grade 4 1,213 |
| | | Grade 5 1,233 |
| | | Grade 6 1,253 |
| | | Grade 7 1,816 |
| | | Grade 8 1,293 |

ZE2

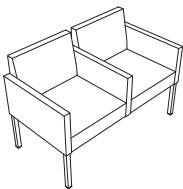

| Description | Dimensions | (in) | (mm) | Dimensions | (in) | (mm) |
|-----------------|-------------|------|------|----------------|------|------|
| 2-seat armchair | Seat width | 20 ½ | 521 | Overall width | 47 | 1194 |
| | Seat depth | 20 | 508 | Overall depth | 24 ½ | 622 |
| | Seat height | 18 | 457 | Overall height | 31 | 787 |
| | Back height | 13 | 330 | | | |

| Model | Frame | Upholstery / List (\$) |
|-------|--------|------------------------|
| ZE2 | E8 Std | Grade 1 1,864 |
| | | Grade 2 1,891 |
| | E9 N/C | Grade 3 1,926 |
| | | Grade 4 1,960 |
| | | Grade 5 1,994 |
| | | Grade 6 2,029 |
| | | Grade 7 3,005 |
| | | Grade 8 2,098 |

ZE2A

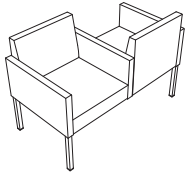

| Description | Dimensions | (in) | (mm) | Dimensions | (in) | (mm) |
|------------------------------|-------------|------|------|----------------|------|------|
| 2-seat armchair, alternating | Seat width | 20 ½ | 521 | Overall width | 47 | 1194 |
| | Seat depth | 20 | 508 | Overall depth | 24 ½ | 622 |
| | Seat height | 18 | 457 | Overall height | 31 | 787 |
| | Back height | 13 | 330 | | | |

| Model | Frame | Upholstery / List (\$) |
|---------------|--------|------------------------|
| ZE2A | E8 Std | Grade 1 1,864 |
| | E9 N/C | Grade 2 1,891 |
| Grade 3 1,926 | | |
| Grade 4 1,960 | | |
| Grade 5 1,994 | | |
| Grade 6 2,029 | | |
| Grade 7 3,005 | | |
| Grade 8 2,098 | | |

ZE1TR

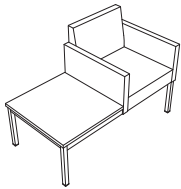

| Description | Dimensions | (in) | (mm) | Dimensions | (in) | (mm) |
|-----------------------------------|-------------|------|------|----------------|------|------|
| 1-seat armchair, right-side table | Seat width | 20 ½ | 521 | Overall width | 47 | 1194 |
| | Seat depth | 20 | 508 | Overall depth | 24 ½ | 622 |
| | Seat height | 18 | 457 | Overall height | 31 | 787 |
| | Back height | 13 | 330 | | | |

| Model | Frame | Upholstery / List (\$) | Table finish |
|---------------|--------|------------------------|-----------------------|
| ZE1TR | E8 Std | Grade 1 1,388 | Specify laminate code |
| | E9 N/C | Grade 2 1,404 | |
| Grade 3 1,424 | | | |
| Grade 4 1,444 | | | |
| Grade 5 1,464 | | | |
| Grade 6 1,484 | | | |
| Grade 7 2,047 | | | |
| Grade 8 1,524 | | | |

ZE1TL

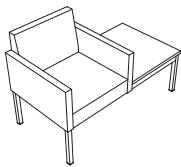

| Description | Dimensions | (in) | (mm) | Dimensions | (in) | (mm) |
|----------------------------------|-------------|------|------|----------------|------|------|
| 1-seat armchair, left-side table | Seat width | 20 ½ | 521 | Overall width | 47 | 1194 |
| | Seat depth | 20 | 508 | Overall depth | 24 ½ | 622 |
| | Seat height | 18 | 457 | Overall height | 31 | 787 |
| | Back height | 13 | 330 | | | |

| Model | Frame | Upholstery / List (\$) | Table finish |
|---------------|--------|------------------------|-----------------------|
| ZE1TL | E8 Std | Grade 1 1,388 | Specify laminate code |
| | E9 N/C | Grade 2 1,404 | |
| Grade 3 1,424 | | | |
| Grade 4 1,444 | | | |
| Grade 5 1,464 | | | |
| Grade 6 1,484 | | | |
| Grade 7 2,047 | | | |
| Grade 8 1,524 | | | |

ZE3

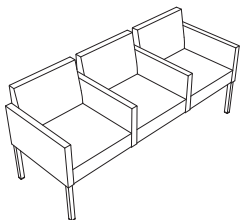

| Description | Dimensions | (in) | (mm) | Dimensions | (in) | (mm) |
|-----------------|-------------|------|------|----------------|------|------|
| 3-seat armchair | Seat width | 20 ½ | 521 | Overall width | 69 ½ | 1765 |
| | Seat depth | 20 | 508 | Overall depth | 24 ½ | 622 |
| | Seat height | 18 | 457 | Overall height | 31 | 787 |
| | Back height | 13 | 330 | | | |

| Model | Frame | Upholstery / List (\$) |
|---------------|--------|------------------------|
| ZE3 | E8 Std | Grade 1 2,433 |
| | E9 N/C | Grade 2 2,474 |
| Grade 3 2,525 | | |
| Grade 4 2,576 | | |
| Grade 5 2,628 | | |
| Grade 6 2,679 | | |
| Grade 7 4,134 | | |
| Grade 8 2,782 | | |

ZE3A

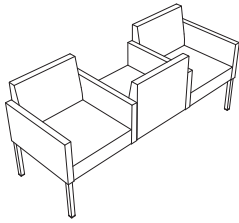

| Description | Dimensions (in) | (mm) | Dimensions (in) | (mm) | | |
|------------------------------|-----------------|------|-----------------|----------------|------|------|
| 3-seat armchair, alternating | Seat width | 20 ½ | 521 | Overall width | 69 ½ | 1765 |
| | Seat depth | 20 | 508 | Overall depth | 24 ½ | 622 |
| | Seat height | 18 | 457 | Overall height | 31 | 787 |
| | Back height | 13 | 330 | | | |

| Model | Frame | Upholstery / List (\$) |
|-------|--------|------------------------|
| ZE3A | E8 Std | Grade 1 2,433 |
| | E9 N/C | Grade 2 2,474 |
| | | Grade 3 2,525 |
| | | Grade 4 2,576 |
| | | Grade 5 2,628 |
| | | Grade 6 2,679 |
| | | Grade 7 4,134 |
| | | Grade 8 2,782 |

ZE2TR

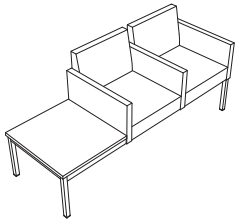

| Description | Dimensions (in) | (mm) | Dimensions (in) | (mm) | | |
|-----------------------------------|-----------------|------|-----------------|----------------|------|------|
| 2-seat armchair, right-side table | Seat width | 20 ½ | 521 | Overall width | 69 ½ | 1765 |
| | Seat depth | 20 | 508 | Overall depth | 24 ½ | 622 |
| | Seat height | 18 | 457 | Overall height | 31 | 787 |
| | Back height | 13 | 330 | | | |

| Model | Frame | Upholstery / List (\$) | Table finis |
|-------|--------|------------------------|-----------------------|
| ZE2TR | E8 Std | Grade 1 2,151 | Specify laminate code |
| | E9 N/C | Grade 2 2,179 | |
| | | Grade 3 2,213 | |
| | | Grade 4 2,248 | |
| | | Grade 5 2,282 | |
| | | Grade 6 2,316 | |
| | | Grade 7 3,293 | |
| | | Grade 8 2,385 | |

ZE2TL

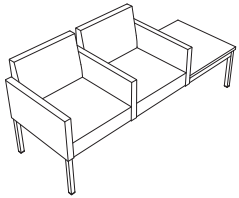

| Description | Dimensions (in) | (mm) | Dimensions (in) | (mm) | | |
|----------------------------------|-----------------|------|-----------------|----------------|------|------|
| 2-seat armchair, left-side table | Seat width | 20 ½ | 521 | Overall width | 69 ½ | 1765 |
| | Seat depth | 20 | 508 | Overall depth | 24 ½ | 622 |
| | Seat height | 18 | 457 | Overall height | 31 | 787 |
| | Back height | 13 | 330 | | | |

| Model | Frame | Upholstery / List (\$) | Table finis |
|-------|--------|------------------------|-----------------------|
| ZE2TL | E8 Std | Grade 1 2,151 | Specify laminate code |
| | E9 N/C | Grade 2 2,179 | |
| | | Grade 3 2,213 | |
| | | Grade 4 2,248 | |
| | | Grade 5 2,282 | |
| | | Grade 6 2,316 | |
| | | Grade 7 3,293 | |
| | | Grade 8 2,385 | |

ZE2TC

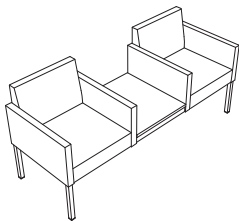

| Description | Dimensions (in) | (mm) | Dimensions (in) | (mm) | | |
|--------------------------------|-----------------|------|-----------------|----------------|------|------|
| 2-seat armchair, central table | Seat width | 20 ½ | 521 | Overall width | 69 ½ | 1765 |
| | Seat depth | 20 | 508 | Overall depth | 24 ½ | 622 |
| | Seat height | 18 | 457 | Overall height | 31 | 787 |
| | Back height | 13 | 330 | | | |

| Model | Frame | Upholstery / List (\$) | Table finis |
|-------|--------|------------------------|-----------------------|
| ZE2TC | E8 Std | Grade 1 2,151 | Specify laminate code |
| | E9 N/C | Grade 2 2,179 | |
| | | Grade 3 2,213 | |
| | | Grade 4 2,248 | |
| | | Grade 5 2,282 | |
| | | Grade 6 2,316 | |
| | | Grade 7 3,293 | |
| | | Grade 8 2,385 | |

ZE01

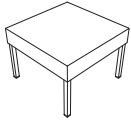

| Description | Dimensions | (in) | (mm) |
|-------------|----------------|------|------|
| Ottoman | Overall width | 24 ½ | 622 |
| | Overall depth | 24 ½ | 622 |
| | Overall height | 18 | 457 |

| Model | Frame | Upholstery / List (\$) |
|-------|--------|------------------------|
| ZE01 | E8 Std | Grade 1 619 |
| | E9 N/C | Grade 2 623 |
| | | Grade 3 628 |
| | | Grade 4 632 |
| | | Grade 5 637 |
| | | Grade 6 642 |
| | | Grade 7 729 |
| | | Grade 8 651 |

ZE02

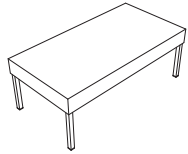

| Description | Dimensions | (in) | (mm) |
|----------------|----------------|------|------|
| 2-seat ottoman | Overall width | 47 | 1194 |
| | Overall depth | 24 ½ | 622 |
| | Overall height | 18 | 457 |

| Model | Frame | Upholstery / List (\$) |
|-------|--------|------------------------|
| ZE02 | E8 Std | Grade 1 944 |
| | E9 N/C | Grade 2 952 |
| | | Grade 3 961 |
| | | Grade 4 971 |
| | | Grade 5 980 |
| | | Grade 6 989 |
| | | Grade 7 1,164 |
| | | Grade 8 1,008 |

ZE03

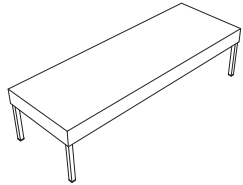

| Description | Dimensions | (in) | (mm) |
|----------------|----------------|------|------|
| 3-seat ottoman | Overall width | 69 ½ | 1765 |
| | Overall depth | 24 ½ | 622 |
| | Overall height | 18 | 457 |

| Model | Frame | Upholstery / List (\$) |
|-------|--------|------------------------|
| ZE03 | E8 Std | Grade 1 1,245 |
| | E9 N/C | Grade 2 1,256 |
| | | Grade 3 1,270 |
| | | Grade 4 1,284 |
| | | Grade 5 1,298 |
| | | Grade 6 1,312 |
| | | Grade 7 1,574 |
| | | Grade 8 1,340 |

ZETA AND TERRA – SOLUTIONS

Replace the "Z" by a "T" at the beginning of each model number to switch to Terra solutions.

ZETA – S1 \$2,971

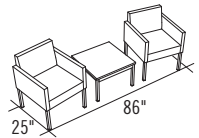

- 2 ZE1
- 1 TE-T2424

ZETA – S3 \$12,979

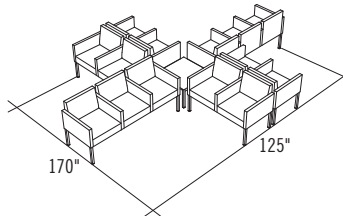

- 4 ZE2
- 2 ZE3
- 1 TE-T2424

ZETA – S2 \$4,015

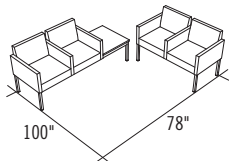

- 1 ZE2
- 1 ZE2TL

ZETA – S4 \$4,641

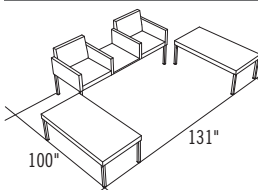

- 4 ZE2TC
- 2 ZE03

ACCESSORIES

GANG2



Description

Ganging device for Cube 200
Includes 2 ganging devices with hardware
Can gang 2 modules together

| Model | List (\$) |
|--------------|-----------|
| GANG2 | 35 |

GANG3

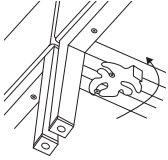

Description

Ganging device for Aerial, Cube 300, Hip Hop, Terra and Zeta
Includes 2 ganging devices with hardware
Can gang 2 modules together

| Model | List (\$) |
|--------------|-----------|
| GANG3 | 35 |

FIX2

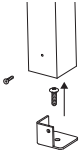

Description

Floor anchors for Cube 200
Includes 2 anchors
Can anchor 2 legs on floor

| Model | List (\$) |
|-------------|-----------|
| FIX2 | 35 |

FIX3

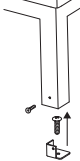

Description

Floor anchors for Aerial, Cube 300, Terra and Zeta
Includes 2 anchors
Can anchor 2 legs on floor

| Model | List (\$) |
|-------------|-----------|
| FIX3 | 35 |

C.O.M./C.O.V. Policy

Fabric approval

All C.O.M./C.O.V. materials must be approved for use by Groupe Lacasse/Arold manufacturing facilities. In order to determine pre-approval, please contact the C.O.M./C.O.V. coordinator at 1-888-522-2773.

To solicit approval, 2 samples (minimum of 8" × 8") need to be forwarded to below address along with the material's specifications to the attention of the C.O.M./C.O.V. coordinator. If California # 117 compliant, the certification must accompany the material. Please ensure that the custom fabric form is completely filled out and sent to the C.O.M./C.O.V. coordinator or the test cannot be processed. The ORIENTATION section is especially important; if it fails to be completed the material will be applied as it comes off the roll.

Groupe Lacasse/Arold

C/O COM Coordinator
147, Saint-Pierre St
Saint-Pie, QC J0H 1W0
Canada

Once the C.O.M./C.O.V. material has been tested, you will be contacted by the C.O.M./C.O.V. coordinator with the results. Upon approval, you will be directed as to any additional yardage requirements beyond the published C.O.M./C.O.V. yardage. To determine amount of upholstery needed, please refer to the C.O.M./C.O.V. designation (model specific) in the login section section of the website (www.groupelacasse.com). Yardage is based on 54" width roll. Some directional or railroaded material may require additional yardage.

All materials are to be received from the vendor clearly marked with your purchase order number, VENDOR-PATTERN-COLOR and quantity of yards. There should not be more than one piece per roll. Back orders or partial shipments will not be accepted. Rolls must not exceed 50 lbs. All C.O.M./C.O.V. material must be shipped prepaid to our manufacturing facility. DO NOT ship C.O.M./C.O.V. material without positive test results.

Once approved, please forward your purchase order to the C.O.M./C.O.V. coordinator (fax: 1-888-248-1865) and the upholstery to the specified address. Surplus material, unused material or material that cannot be identified will be discarded after 60 days. C.O.M./C.O.V. upholstery is subject to final approval upon arrival. It is the responsibility of the customer or customer's vendor to inspect material for bias and/or flaws prior to shipment to Groupe Lacasse/Arold.

Disclaimer

The Seller reserves the right to approve all C.O.M./C.O.V. prior to acceptance. Even after preliminary approval, the Seller reserves the right to reject C.O.M./C.O.V. if tests or early production results indicate the material will not meet the Seller's quality standards or excessive unforeseen costs will be incurred. For accepted C.O.M./C.O.V., the Seller assumes no responsibility for its appearance, quality, durability, colorfastness or any other attributes after application to a Arold product. The Seller will determine any additional yardage, labor charges or surcharges that may be required as a condition of C.O.M./C.O.V. acceptance.

Purchase orders will not be processed until material has been approved and production cannot be scheduled until upholstery has been received. Upon completing these steps, your ship date will be determined. The Seller may split an order at the customer's request and may be subject to a minimum order charge.

The Seller is not responsible for excess C.O.M./C.O.V. from completed orders unless express agreement has been reached in advance. The customer is responsible for the return of any excess material. C.O.M./C.O.V. orders may not be changed or cancelled after acknowledgement.

Please consult the C.O.M./C.O.V. coordinator (1-888-522-2773) with any questions regarding this process.

Pricing

C.O.M. (FABRIC): is priced at Grade 2.

C.O.V. (VINYL): is priced at Grade 3.

For internal use only

Tracking #

Date



Custom Fabric Form

All information below needs to be supplied in order to process your request and two test swatches (minimum 8" x 8") must be sent. Additional material may be requested. Please include this form and a Cal-117 certification (if applicable) to all test requests. If fabric is reversible, please indicate up side with a color swatch. Remember that fabric (C.O.M.) is priced at grade 2 and vinyl (C.O.V.) is priced at grade 3. Contact the C.O.M. coordinator with any questions.

Please fax this form to Arold C.O.M./C.O.V. coordinator at 1-888-248-1865 (send only if testing is required).

General information

| | |
|-----------------|-----------------|
| Date of request | Bill to address |
| Customer name | |
| Contact person | |
| Phone | |
| Email address | |

Textile information

| Test # | Results | | Supplier | Pattern name | Pattern # | Colour |
|--------|---------|--------|----------|--------------|-----------|--------|
| | Passed | Failed | | | | |
| 1. | | | | | | |
| 2. | | | | | | |
| 3. | | | | | | |
| 4. | | | | | | |
| 5. | | | | | | |

For internal use only

| | Please check | | Orientation | | Reversible fabric? | | Is fabric Cal-117? | | Backer type |
|----|--------------|-------|--------------|------------|--------------------|----|--------------------|----|-----------------|
| | Fabric | Vinyl | Off the roll | Railroaded | Yes | No | Yes | No | (If applicable) |
| 1. | | | | | | | | | |
| 2. | | | | | | | | | |
| 3. | | | | | | | | | |
| 4. | | | | | | | | | |
| 5. | | | | | | | | | |

Other comments

Terms and Conditions

Order placement

Groupe Lacasse* requires that all orders must be submitted in writing as represented by a valid purchase order on company letterhead, which includes the total list and net dollars. This is to ensure that orders are complete, to avoid errors, and to avoid duplication. Please order product by number in order to avoid any possible error. Telephone orders will not be processed for production without proper written confirmation. Groupe Lacasse* will not be responsible for errors, omissions and order duplication due to non-compliance with this procedure.

Ordering information

The following information is required to process an order:

Customer information

Sold/Ship to address
Purchase order number
Authorized signature
Contact name and phone
Consignee contact name and phone
Tagging instructions
Bid/Quote # if applicable
Product pricing (list/net)
Order total (list/net)
Preferred delivered date
(specific delivery date not guaranteed)

Product information

Quantity
Product numbers including options
Fabric and colours (all surfaces)

Order changes

Any change to an original purchase order must be received in writing no later than 48 hours after receipt of the original order. Any change to the original order after 48 hours, if approved, will result in production rescheduling. The cost variances will have to be approved by our Customer Service before production rescheduling.

Order cancellations

Cancellations must be requested in writing no later than 48 hours after receipt of the original order and are subject to approval by Groupe Lacasse*. Cancellations cannot be accepted otherwise.

Order acknowledgment

Orders will be acknowledged by Groupe Lacasse*. Please refer to the acknowledgment copy to make sure it agrees with your original purchase order. When corresponding, please refer to the acknowledgment number.

Returns

Products are made-to-order and may not be cancelled or returned. For warranty issues, please contact Customer Service. The Seller reserves the right to recall any defective items for evaluation.

Surcharges

Expedited Transportation

No shipments have guaranteed delivery time and/or date. Time-sensitive deliveries that require expedited carrier service will result in additional charges that will be passed on to the consignee (dealer).

Prices

All prices listed are suggested retail prices, F.C.A. destination. Orders are accepted subject to prices and taxes prevailing at the time of shipment. Prices and taxes are subject to change without notice. If shipping date requested is more than 90 days from date of order, Groupe Lacasse* shall have the right to use the published list prices effective at the time of shipment.

Chargeable Parts Orders

Contact customer service for availability. Orders under \$25 are subject to a \$20 minimum parts order charge. The small order charge does not apply to replacement parts orders. Service parts prices are subject to change without notice or approval. Price list dated January 5, 2015 supersedes all other published price lists. Prices shown in price book have priority to electronic catalog contents.

Terms

Terms of sale are net 30 days to firms who have established satisfactory credit; otherwise we reserve the right to request cash in advance. Interest on past due accounts shall be 2% per month (24% per year). Should the Buyer fail to fulfill the above-mentioned terms of payment, Groupe Lacasse* reserves the right to defer further shipments until the Buyer has satisfied all solvency criteria and terms of payment as determined by Groupe Lacasse*. Any product sold shall remain the property of Groupe Lacasse* and shall remain the Seller's property until paid for in full. The Buyer agrees to perform all acts which may be necessary to protect and assure retention of title to such products by Groupe Lacasse* until such time as goods have been paid for in full.

Credit

Credit may be established for sales on open account by submitting satisfactory references. A line of credit will be set by our credit department. We may change or cancel credit terms at our discretion and request advance payment at our option. A delay in providing credit information may delay order entry and the shipping date of an order. The Seller reserves the right to delay or cancel any shipment to a customer whose account balance is over the credit limit and/or past due. We do not ship C.O.D. Inactive account of more than one (1) year will result in a reevaluation of the account.

Applicable prices

List prices and discounts are subject to change without notice or approval. Applicable prices are those in effect at the time of the receipt of an order; we reserve the right to use the published list prices effective at the time of shipment if the requested ship date is more than 90 days after the order receipt date. Prices shown in price book have priority to electronic catalog contents.

Services

List prices apply to products only. If, as a result of customer request, the dealer or authorized representative provides planning/design services, storage, special handling, set-up, or installation, the customer will be charged at the local dealer or authorized representative's standard rate.

Quotations

Quotations are valid for a period of thirty (30) days.

Changes

All illustrations, specifications and prices in this book are based on the latest product information available at the time of publication. The right is reserved to make changes, at any time and without prior notice, to prices, colours, materials, specifications and models offered.

Delivery

The scheduled delivery week is specified on our acknowledgment. Groupe Lacasse* is not liable for delay or failure to deliver goods due to causes beyond its control. Groupe Lacasse* will only make on site deliveries for a half truck (1200 square feet). An unloading dock must be available to accommodate 53 feet trailers and address is subject to approval. Unloading at destination is the responsibility of the purchaser. Our standard carriers do not have liftgates. Request for liftgates can often be accommodated with a minimum notice of 2 weeks but will result in extra fees. Time sensitive deliveries that require expedited carrier service will result in additional charges that will be passed onto the consignee (dealer). Under no circumstance will Groupe Lacasse deliver goods in a residential area. Groupe Lacasse cannot accommodate inside deliveries.

Ship dates and delays

If the Seller cannot ship products due to causes beyond its reasonable control (such as casualty, acts of nature, labor disputes, or accident; inability to obtain necessary labor, material or transportation; changes requested by the customer), the ship date will be extended to compensate for the delay as determined by the Seller.

Routing

Unless otherwise specified by the buyer and agreed to by Groupe Lacasse*, the latter reserves the right to select the route, method of shipment and carrier. Customer requests for special carrier, method of shipment and/or routing will be shipped freight collect.

Transportation policy

This map is for Groupe Lacasse's US market deliveries.

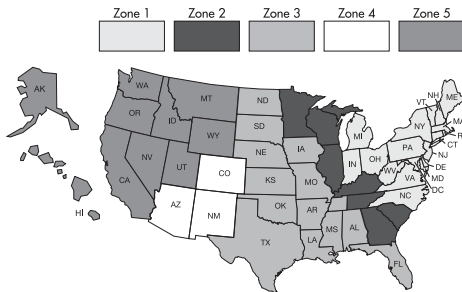

"Zone 0" shipments are FCA plant.

"Zone 1", "Zone 2", "Zone 3", "Zone 4" and "Zone 5" pricing includes freight cost to your geographical location.

On orders less than \$2,000 net (regardless of brand and/or shipping point) we will add a \$50 small order fee in "Zone 1". For "Zone 2", "Zone 3", "Zone 4" and "Zone 5", the small order fee is \$100.

Orders under \$25 net are subject to a \$20 small order fee (instead of 50\$ or 100\$) regardless of the shipping zone.

Freight charges beyond the continental United States are the purchaser's responsibility. Shipments beyond the continental United States must deliver to a freight forwarder or forwarding carrier of your choice. It is the customer's responsibility to provide this information on purchase orders.

Storage

In the event the purchaser request postponement of shipment beyond the scheduled shipping week after the goods have become work in process, or are ready to be shipped, Groupe Lacasse* can take arrangements to store the goods but at the purchaser's risk and expense. Such transfer to storage shall be deemed delivery to purchaser for all purposes including invoicing and payment.

Freight claims

All FCA destination claims will be handled and filed by the Seller. In order to expedite any credit due, your help and assistance is required. Please adhere to the following guidelines. The merchandise is carefully packed and thoroughly inspected before leaving the warehouse. Responsibility for its safe delivery is assumed by the carrier upon acceptance of the shipment. Claims for loss or damage sustained in transit must therefore be made to Groupe Lacasse* as follows:

A. Concealed loss or damage

Concealed loss or damage means loss or damage that does not become apparent until the merchandise has been unpacked. The contents may be damaged in transit due to rough handling even though the carton may not show external damage. When damage is discovered upon unpacking, a written request must be made to Groupe Lacasse Customer Service within 15 days of the receiving date. No disposition will be taken until approved by the manufacturer.

IMPORTANT: Groupe Lacasse's policy in concealed damage is to replace the part or complete product if necessary at no charge to the dealer. However, it is the responsibility of the dealer to provide installation of the replaced part or complete product. Therefore, no labor fees will be accepted on concealed damages.

B. Visible damage or shortage

Any external evidence of damage or shortage must be noted on the freight bill or express receipts and signed by the carrier's agent. Failure to adequately describe such external evidence of damage or shortage may result in refusing to honor a damage claim. When damage or shortage is discovered, a written request must be made to Groupe Lacasse Customer Service within 5 days of the receiving date.

For claims, please contact **Groupe Lacasse Customer Service** by phone at **1-888-522-2773**, by fax at **1-888-248-1865** or by email at LacasseCustomerservice@groupelacasse.com.

Product

A. Use and installation of products

The Seller recommends that its products be installed according to its written installation procedures. The customer agrees to use the Seller's products properly; not to remove or alter safety devices, warnings, or operation instructions placed on products by the Seller and to instruct employees as to the proper care and use of the products according to printed instructions. Installers can be contracted through one of the Seller's dealer or affiliate on a separately negotiated basis.

B. Service

Service requests for design, installation, relocation, storage, trade-in, etc. are handled by the local authorized dealer. Contact the local authorized dealer for more details.

C. Design

We reserve the right to make changes in product offering, design and materials as well as discontinuance of parts and units when such action is deemed to be an improvement in design or function.

**To lighten the text, the term Groupe Lacasse here is meant to include Groupe Lacasse LLC (US market) and Groupe Lacasse Inc. (Canadian market).*

Warranty

The following warranty applies to Arold products manufactured after January 5, 2015. This warranty is given to the initial buyer and is valid for as long as the product is owned by the original buyer. The warranty, which runs from the date of manufacture, covers defects in materials and craftsmanship found during normal usage of products during the applicable warranty period.

Warranty:

Groupe Lacasse LLC warrants its products, from the date of invoice, to be free from defects in material and workmanship for as long as the original purchaser owns it; proof of delivery being the only official document accepted by Groupe Lacasse LLC for any claim. This warranty is subject to the limitations, exclusions and other provisions below: Lifetime except those listed below. Weight limit: 250 lbs. (141 kg).

| Arold Products | Applicable Warranty Period |
|---|----------------------------|
| C.O.M./C.O.V./SPL/ Lacasse To Supply Material Program: | Not warranted |
| Casters/Glides | 5 years |
| Electrical components | 5 years |
| Exposed wood | 2 years |
| Foam | 5 years |
| High-performance thermofused laminate | 25 years |
| Internal wood frame | Lifetime |
| Metal frames | Lifetime |
| Standard upholstery and Graded-in | 5 years |
| Workmanship | 10 years |

Labor, delivery charges and service not covered under warranty.

This warranty does not apply to “normal wear and tear”, abuse, damage caused by a carrier, damaged caused by transport of product from one site or location to another and alterations to the product not expressly authorized by the Seller. It also does not apply to “Customer’s Own Material”, “Lacasse – To Supply Material” and “SPL” fabric, (i.e., material specified by the buyer that is not a standard Arold product offering) used in the manufacture of Arold products. The Seller does not warrant the matching of colour, grain or texture except to within commercially acceptable standards. For the purposes of warranty claims, upholstery fabrics that have been dropped from Arold stocked fabric program will be supported for 6 months from the date of discontinuation. For fabrics that are no longer available from the manufacturer, substitute fabrics will be used for warranty claims.

A product will not be considered defective, and it will not be subject to the warranty, if the product is not installed or used as recommended in the Seller’s written planning, installation or user guides. The warranty does not apply to any Arold seating product that is used by an individual weighing over 250 lbs. (113 kg). Warranty will be void if identification label is removed under the chair or if a proof of purchase cannot be supplied, such as an order number or an invoice.

Except as stated above, the Seller does not make any express or implied warranties as to any product and in particular does not make any warranty of fitness for any particular purpose except for standard use of no more than 40 hours per week. The remedies described above are the buyer’s exclusive remedies for any product defect. The Seller shall not be liable for consequential, economic, indirect, punitive or incidental damages arising from any product defect.

* The applicable warranty period assumes that the product is used an average of not more than 40 hours per week. If a product is used more than this, the applicable warranty period shall be reduced in proportion to the increased usage. For example, if casters are used an average of 50 hours per week, the applicable warranty period for the casters shall be reduced to four years.

Lacasse thermofused laminate finishe

| | | | | | |
|--------------------------------|------------------------------|------------------------------|----------------------------|-----------------------------|-----------------------------|
| ACA – Mahogany | CER – Cherry | FOS – Fossil | GVR – Frost | NTL – Natural Cherry | TWT – Tuscany Walnut |
| BUC – Bourbon Cherry | CLY – Clay | GAN – Anthracite Grey | HZN – Hazelnut | PCM – Parchment | WGR – Willow Grey |
| CAR – Caramello | DCH – Dark Chocolate | GGI – Grigio | NCN – Crystal Black | RBY – Ruby | |
| CCL – Classic Chocolate | ERH – Hard Rock Maple | GIN – Ginger | NRM – Natural Maple | SNO – Snow | |

Arold wood finishe

| | | | |
|----------------------------|--------------------|------------------------|---------------------|
| W1 – Tobacco Cherry | W2 – Cherry | W3 – Shadow Oak | W4 – Natural |
|----------------------------|--------------------|------------------------|---------------------|

Sample order

| | | | |
|--------------------------------------|--------------------------------------|---|--|
| A With button | CSW Contrast stitching, white | HR Headrest | TAL Tablet arm on left (<i>while seated</i>) |
| SA Without button | DH 3" higher back | PC Electrical/Communication module | TAR Tablet arm on right (<i>while seated</i>) |
| CSB Contrast stitching, black | HDW Hard dual wheel casters | SDW Soft dual wheel casters | ML Metal legs |



Aroid

CONTRACT • CONTRAT

A GROUPE LACASSE BRAND

GROUPE
LACASSE

1 888 522.2773 www.grounelacasse.com

