

MODULAR, LOUNGE AND PUBLIC AREAS

SPECIFICATIONS

- All models ship assembled.
- Fabric/fabric, fabric/vinyl and vinyl/vinyl dual upholstery is available for the double ogive and chairs only. The first upholstery code is the backrest, the second upholstery code is for the seat.
- If dual upholstery combination is from two different grades, list price is the highest grade of the two.
- Leather is not available for these series.
- Metallic silver electrical modules with 2 power outlets and 2 USB 2.1 connectors available on laminate surfaces. All electrical modules are rectangular except for ottomans which come with round modules. Specify this option by adding **PC**. The modules come installed.
- All models come standard with 1/4" thick bended steel legs, 9 1/2" H on Hip Hop and 6"H on Hip Hop Junior products.
- Optional 1/4" thick laser cut metal leg, 9 1/2" H on Hip Hop (not available in standard on Hip Hop Junior). Specify this option using **K** followed by the finish.
- Choice of several leg finishes: Silver Metallic **8**, Nu Nickel **9** and Polished Chrome **1**.
- Please refer to the Lacasse Sampler for laminate choices.
- Please consult the Arold Price Book, Accessories section on page 53 for information on ganging brackets.
- C.O.M./C.O.V. available. Please refer to page 54 of the Arold Price Book.

CALCULATING RADIUS:

The radius is the linear distance calculated from the center of the circle (point 0) to the inner circumference of the module.

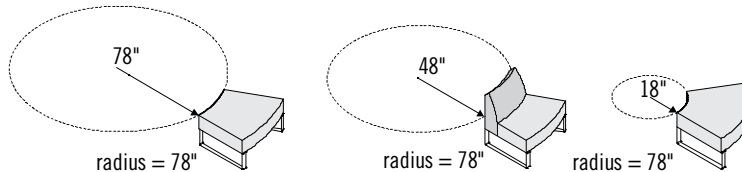

CALCULATING DEGREES:

The degree of the angle is calculated by dividing the entire circumference (360°) by the number of modules. E.g.: 360 divided by 6 modular units provides an angle of 60°.

Thus, 12 modules of 30° form a circle (360°).

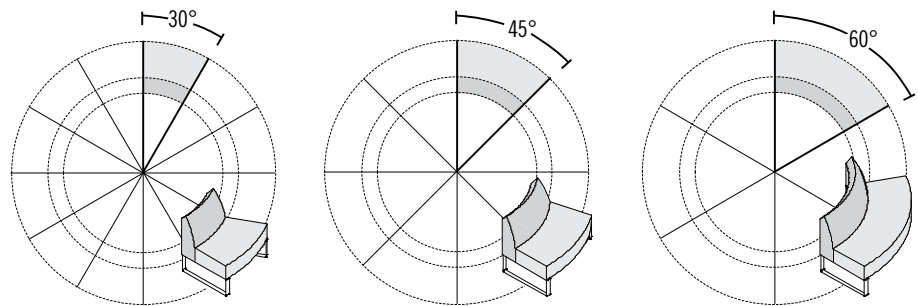

ELECTRICAL MODULE:

The position of electrical modules depending on model type.

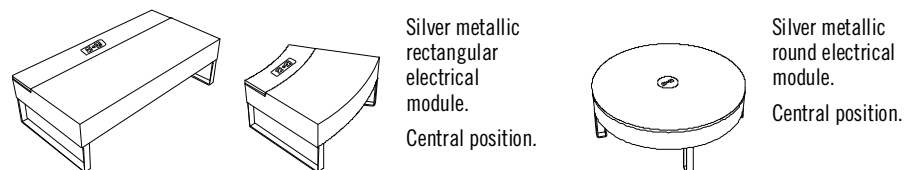

DUAL UPHOLSTERY APPLICATION

SAMPLE ORDER: HV-E9-**CY32**-**HU10**

①

②

HV

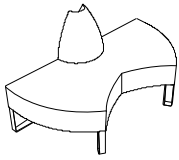

Description	Dimensions	(in)	(mm)	Dimensions	(in)	(mm)
Double ogive seat	Seat width	60	1524	Overall width	60	1524
	Seat depth	21	533	Overall depth	30	762
	Seat height	18	457	Overall height	34	864
	Back height	16	406			

Model	Frame	Upholstery / List (\$)
HV	E8 Std	Grade 1 2,577
	E9 N/C	Grade 2 2,592
	E1 320	Grade 3 2,610
	K8 220	Grade 4 2,629
	K9 220	Grade 5 2,648
	K1 495	Grade 6 2,667
		Grade 8 2,704

HO

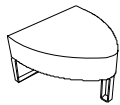

Description	Dimensions	(in)	(mm)	Dimensions	(in)	(mm)
Ogive	Seat width	30	762	Overall width	30	762
	Seat depth	30	762	Overall depth	30	762
	Seat height	18	457	Overall height	18	457

Model	Frame	Upholstery / List (\$)
HO	E8 Std	Grade 1 1,226
	E9 N/C	Grade 2 1,237
	E1 225	Grade 3 1,251
	K8 200	Grade 4 1,265
	K9 200	Grade 5 1,279
	K1 400	Grade 6 1,293
		Grade 8 1,321

H30

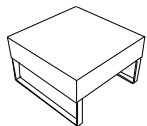

Description	Dimensions	(in)	(mm)	Dimensions	(in)	(mm)
Square bench	Seat width	30	762	Overall width	30	762
	Seat depth	30	762	Overall depth	30	762
	Seat height	18	457	Overall height	18	457

Model	Frame	Upholstery / List (\$)
H30	E8 Std	Grade 1 969
	E9 N/C	Grade 2 979
	E1 225	Grade 3 992
	K8 200	Grade 4 1,004
	K9 200	Grade 5 1,017
	K1 400	Grade 6 1,029
		Grade 8 1,054

H30X

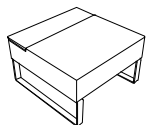

Description	Dimensions	(in)	(mm)	Dimensions	(in)	(mm)
Mixed square bench	Seat width	30	762	Overall width	30	762
	Seat depth	21	533	Overall depth	30	762
	Seat height	18	457	Overall height	18	457

Model	Frame	Upholstery / List (\$)	Tablet finish	Other options (\$)
H30X	E8 Std	Grade 1 1,144	Specify laminate code	PC (1x) 600
	E9 N/C	Grade 2 1,154		
	E1 225	Grade 3 1,167		
	K8 200	Grade 4 1,180		
	K9 200	Grade 5 1,192		
	K1 400	Grade 6 1,205		
		Grade 8 1,230		

HC30

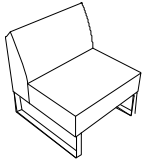

Description	Dimensions (in)	(mm)	Dimensions (in)	(mm)		
Straight chair	Seat width	30	762	Overall width	30	762
	Seat depth	21	533	Overall depth	30	762
	Seat height	18	457	Overall height	34	864
	Back height	16	406			
	Back width	30	762			

Model	Frame	Upholstery / List (\$)
HC30	E8 Std	Grade 1 1,370
	E9 N/C	Grade 2 1,384
	E1 225	Grade 3 1,402
	K8 200	Grade 4 1,420
	K9 200	Grade 5 1,439
	K1 400	Grade 6 1,457
		Grade 7 1,475
		Grade 8 1,493

H60

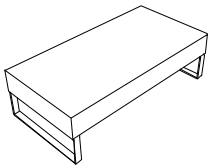

Description	Dimensions (in)	(mm)	Dimensions (in)	(mm)		
Rectangular bench	Seat width	60	1524	Overall width	60	1524
	Seat depth	30	762	Overall depth	30	762
	Seat height	18	457	Overall height	34	864
	Back height	16	406			

Model	Frame	Upholstery / List (\$)
H60	E8 Std	Grade 1 1,582
	E9 N/C	Grade 2 1,596
	E1 225	Grade 3 1,613
	K8 200	Grade 4 1,630
	K9 200	Grade 5 1,646
	K1 400	Grade 6 1,663
		Grade 7 1,680
		Grade 8 1,697

H60X

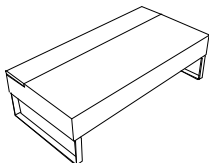

Description	Dimensions (in)	(mm)	Dimensions (in)	(mm)		
Mixed rectangular bench	Seat width	60	1524	Overall width	60	1524
	Seat depth	30	762	Overall depth	30	762
	Seat height	18	457	Overall height	18	457

Model	Frame	Upholstery / List (\$)	Tablet finish	Other options (\$)
H60X	E8 Std	Grade 1 1,839	Specify laminate code	PC (1x) 600
	E9 N/C	Grade 2 1,853		
	E1 225	Grade 3 1,870		
	K8 200	Grade 4 1,888		
	K9 200	Grade 5 1,905		
	K1 400	Grade 6 1,923		
		Grade 7 1,940		
		Grade 8 1,958		

HC60

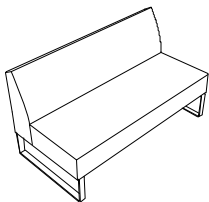

Description	Dimensions (in)	(mm)	Dimensions (in)	(mm)		
Straight chair	Seat width	60	1524	Overall width	60	1524
	Seat depth	21	533	Overall depth	30	762
	Seat height	18	457	Overall height	34	864
	Back height	16	406			
	Back width	60	1524			

Model	Frame	Upholstery / List (\$)
HC60	E8 Std	Grade 1 2,201
	E9 N/C	Grade 2 2,230
	E1 225	Grade 3 2,266
	K8 200	Grade 4 2,301
	K9 200	Grade 5 2,337
	K1 400	Grade 6 2,373
		Grade 7 2,409
		Grade 8 2,444

H1860

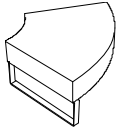

Description	Dimensions	(in)	(mm)	Dimensions	(in)	(mm)
Wedge bench	Seat width	48	1219	Overall width	48	1219
Radius = 18"	Seat depth	30	762	Overall depth	32 ½	826
Degree = 60°	Seat height	18	457	Overall height	18	457

Model	Frame	Upholstery / List (\$)	
H1860	E8 Std	Grade 1	1,532
	E9 N/C	Grade 2	1,545
	E1 225	Grade 3	1,560
	K8 200	Grade 4	1,576
	K9 200	Grade 5	1,592
	K1 400	Grade 6	1,607
		Grade 8	1,639

HX1860

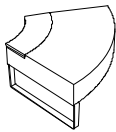

Description	Dimensions	(in)	(mm)	Dimensions	(in)	(mm)
Mixed wedge bench	Seat width	48	1219	Overall width	48	1219
Radius = 18"	Seat depth	21	533	Overall depth	32 ½	826
Degree = 60°	Seat height	18	457	Overall height	18	457

Model	Frame	Upholstery / List (\$)		Tablet finish	Other options (\$)	
HX1860	E8 Std	Grade 1	1,745	Specify laminate code	PC (1x)	600
	E9 N/C	Grade 2	1,757			
	E1 225	Grade 3	1,773			
	K8 200	Grade 4	1,789			
	K9 200	Grade 5	1,804			
	K1 400	Grade 6	1,820			
		Grade 8	1,851			

H1860X

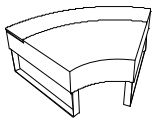

Description	Dimensions	(in)	(mm)	Dimensions	(in)	(mm)
Mixed wedge bench	Seat width	39	991	Overall width	48	1219
Radius = 18"	Seat depth	21	533	Overall depth	32 ½	826
Degree = 60°	Seat height	18	457	Overall height	18	457

Model	Frame	Upholstery / List (\$)		Tablet finish	Other options (\$)	
H1860X	E8 Std	Grade 1	1,745	Specify laminate code	PC (1x)	600
	E9 N/C	Grade 2	1,757			
	E1 225	Grade 3	1,773			
	K8 200	Grade 4	1,789			
	K9 200	Grade 5	1,804			
	K1 400	Grade 6	1,820			
		Grade 8	1,851			

HC1860

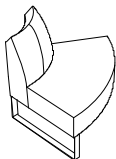

Description	Dimensions	(in)	(mm)	Dimensions	(in)	(mm)
Wedge chair	Seat width	48	1219	Overall width	48	1219
Radius = 18"	Seat depth	21	533	Overall depth	32 ½	826
Degree = 60°	Seat height	18	457	Overall height	34	864
	Back height	16	406			
	Back width	27	686			

Model	Frame	Upholstery / List (\$)	
HC1860	E8 Std	Grade 1	1,895
	E9 N/C	Grade 2	1,915
	E1 225	Grade 3	1,940
	K8 200	Grade 4	1,965
	K9 200	Grade 5	1,990
	K1 400	Grade 6	2,015
		Grade 8	2,065

H1860C

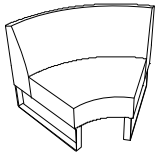

Description	Dimensions (in)	(mm)	Dimensions (in)	(mm)		
Wedge chair	Seat width	39	991	Overall width	48	1219
Radius = 18"	Seat depth	21	533	Overall depth	32 ½	826
Degree = 60°	Seat height	18	457	Overall height	34	864
	Back height	16	406			
	Back width	39	991			

Model	Frame	Upholstery / List (\$)
H1860C	E8 Std	Grade 1 1,895
	E9 N/C	Grade 2 1,916
	E1 225	Grade 3 1,943
	K8 200	Grade 4 1,969
	K9 200	Grade 5 1,996
	K1 400	Grade 6 2,023
		Grade 7 2,050
		Grade 8 2,076

H4830

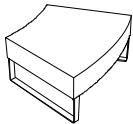

Description	Dimensions (in)	(mm)	Dimensions (in)	(mm)		
Wedge bench	Seat width	40 ¼	1022	Overall width	40 ¼	1022
Radius = 18"	Seat depth	30	762	Overall depth	31 ¾	806
Degree = 30°	Seat height	18	457	Overall height	18	457

Model	Frame	Upholstery / List (\$)
H4830	E8 Std	Grade 1 1,420
	E9 N/C	Grade 2 1,431
	E1 225	Grade 3 1,444
	K8 200	Grade 4 1,458
	K9 200	Grade 5 1,472
	K1 400	Grade 6 1,486
		Grade 7 1,500
		Grade 8 1,513

HX4830

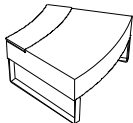

Description	Dimensions (in)	(mm)	Dimensions (in)	(mm)		
Mixed wedge bench	Seat width	40 ¼	1022	Overall width	40 ¼	1022
Radius = 48"	Seat depth	21	533	Overall depth	31 ¾	806
Degree = 30°	Seat height	18	457	Overall height	18	457

Model	Frame	Upholstery / List (\$)	Tablet finish	Other options (\$)
HX4830	E8 Std	Grade 1 1,632	Specify laminate code	PC (1x) 600
	E9 N/C	Grade 2 1,642		
	E1 225	Grade 3 1,655		
	K8 200	Grade 4 1,667		
	K9 200	Grade 5 1,680		
	K1 400	Grade 6 1,692		
		Grade 7 1,705		
		Grade 8 1,717		

H4830X

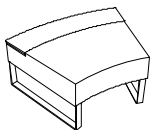

Description	Dimensions (in)	(mm)	Dimensions (in)	(mm)		
Mixed wedge bench	Seat width	35 ¾	909	Overall width	40 ¼	1022
Radius = 48"	Seat depth	21	533	Overall depth	31 ¾	806
Degree = 30°	Seat height	18	457	Overall height	18	457

Model	Frame	Upholstery / List (\$)	Tablet finish	Other options (\$)
H4830X	E8 Std	Grade 1 1,632	Specify laminate code	PC (1x) 600
	E9 N/C	Grade 2 1,642		
	E1 225	Grade 3 1,655		
	K8 200	Grade 4 1,667		
	K9 200	Grade 5 1,680		
	K1 400	Grade 6 1,692		
		Grade 7 1,705		
		Grade 8 1,717		

HC4830

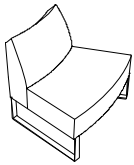

Description	Dimensions	(in)	(mm)	Dimensions	(in)	(mm)
Wedge chair	Seat width	40 ¼	1022	Overall width	40 ¼	1022
Radius = 48"	Seat depth	21	533	Overall depth	31 ¾	806
Degree = 30°	Seat height	18	457	Overall height	34	864
	Back height	16	406			
	Back width	29 ½	749			

Model	Frame	Upholstery / List (\$)
HC4830	E8 Std	Grade 1 1,789
	E9 N/C	Grade 2 1,809
	E1 225	Grade 3 1,834
	K8 200	Grade 4 1,859
	K9 200	Grade 5 1,884
	K1 400	Grade 6 1,909
		Grade 8 1,959

H4830C

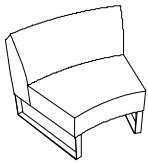

Description	Dimensions	(in)	(mm)	Dimensions	(in)	(mm)
Wedge chair	Seat width	35 ¾	909	Overall width	40 ¼	1022
Radius = 48"	Seat depth	21	533	Overall depth	31 ¾	806
Degree = 30°	Seat height	18	457	Overall height	34	864
	Back height	16	406			
	Back width	35 ¾	909			

Model	Frame	Upholstery / List (\$)
H4830C	E8 Std	Grade 1 1,789
	E9 N/C	Grade 2 1,809
	E1 225	Grade 3 1,834
	K8 200	Grade 4 1,859
	K9 200	Grade 5 1,884
	K1 400	Grade 6 1,909
		Grade 8 1,959

H4845

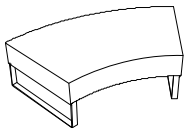

Description	Dimensions	(in)	(mm)	Dimensions	(in)	(mm)
Wedge bench	Seat width	60	1524	Overall width	60	1524
Radius = 48"	Seat depth	30	762	Overall depth	34	864
Degree = 45°	Seat height	18	457	Overall height	18	457

Model	Frame	Upholstery / List (\$)
H4845	E8 Std	Grade 1 1,870
	E9 N/C	Grade 2 1,882
	E1 320	Grade 3 1,898
	K8 220	Grade 4 1,914
	K9 220	Grade 5 1,929
	K1 495	Grade 6 1,945
		Grade 8 1,976

HX4845

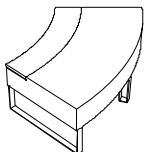

Description	Dimensions	(in)	(mm)	Dimensions	(in)	(mm)
Mixed wedge bench	Seat width	60	1524	Overall width	60	1524
Radius = 48"	Seat depth	21	533	Overall depth	34	864
Degree = 45°	Seat height	18	457	Overall height	18	457

Model	Frame	Upholstery / List (\$)	Tablet finish	Other options (\$)
HX4845	E8 Std	Grade 1 2,158	Specify laminate code	PC (1x) 600
	E9 N/C	Grade 2 2,170		
	E1 320	Grade 3 2,186		
	K8 220	Grade 4 2,201		
	K9 220	Grade 5 2,217		
	K1 495	Grade 6 2,233		
		Grade 8 2,264		

H4845X

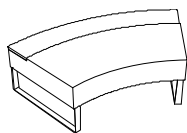

Description	Dimensions	(in)	(mm)	Dimensions	(in)	(mm)
Mixed wedge bench	Seat width	53	1346	Overall width	60	1524
Radius = 48"	Seat depth	21	533	Overall depth	34	864
Degree = 45°	Seat height	18	457	Overall height	18	457

Model	Frame	Upholstery / List (\$)	Tablet finish	Other options (\$)
H4845X	E8 Std	Grade 1 2,158	Specify laminate code	PC (1x) 600
	E9 N/C	Grade 2 2,170		
	E1 320	Grade 3 2,186		
	K8 220	Grade 4 2,201		
	K9 220	Grade 5 2,217		
	K1 495	Grade 6 2,233		
		Grade 8 2,264		

HC4845

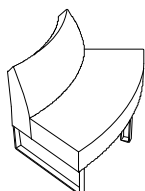

Description	Dimensions	(in)	(mm)	Dimensions	(in)	(mm)
Wedge chair	Seat width	44	1118	Overall width	60	1524
Radius = 48"	Seat depth	21	533	Overall depth	34	864
Degree = 45°	Seat height	18	457	Overall height	34	864
	Back height	16	406			
	Back width	43 3/8	1108			

Model	Frame	Upholstery / List (\$)
HC4845	E8 Std	Grade 1 2,364
	E9 N/C	Grade 2 2,389
	E1 320	Grade 3 2,420
	K8 220	Grade 4 2,452
	K9 220	Grade 5 2,483
	K1 495	Grade 6 2,514
		Grade 8 2,577

H4845C

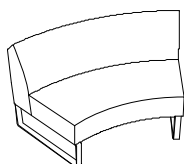

Description	Dimensions	(in)	(mm)	Dimensions	(in)	(mm)
Wedge chair	Seat width	53	1346	Overall width	60	1524
Radius = 48"	Seat depth	21	533	Overall depth	34	864
Degree = 45°	Seat height	18	457	Overall height	34	864
	Back height	16	406			
	Back width	53	1346			

Model	Frame	Upholstery / List (\$)
H4845C	E8 Std	Grade 1 2,364
	E9 N/C	Grade 2 2,389
	E1 320	Grade 3 2,420
	K8 220	Grade 4 2,452
	K9 220	Grade 5 2,483
	K1 495	Grade 6 2,514
		Grade 8 2,577

H4860

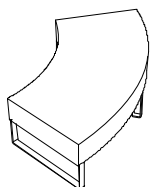

Description	Dimensions	(in)	(mm)	Dimensions	(in)	(mm)
Wedge bench	Seat width	78	1981	Overall width	78	1981
Radius = 48"	Seat depth	30	762	Overall depth	37	940
Degree = 60°	Seat height	18	457	Overall height	18	457

Model	Frame	Upholstery / List (\$)
H4860	E8 Std	Grade 1 2,258
	E9 N/C	Grade 2 2,273
	E1 320	Grade 3 2,291
	K8 220	Grade 4 2,310
	K9 220	Grade 5 2,329
	K1 495	Grade 6 2,348
		Grade 8 2,385

HX4860

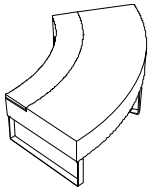

Description	Dimensions (in)	(mm)	Dimensions (in)	(mm)
Mixed wedge bench	Seat width	78	1981	Overall width
Radius = 48"	Seat depth	21	533	Overall depth
Degree = 60°	Seat height	18	457	Overall height

Model	Frame	Upholstery / List (\$)	Tablet finish	Other options (\$)
HX4860	E8 Std	Grade 1 2,564	Specify laminate code	PC (1x) 600
	E9 N/C	Grade 2 2,579		
	E1 320	Grade 3 2,598		
	K8 220	Grade 4 2,617		
	K9 220	Grade 5 2,635		
	K1 495	Grade 6 2,654		
		Grade 8 2,692		

H4860X

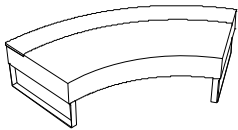

Description	Dimensions (in)	(mm)	Dimensions (in)	(mm)
Mixed wedge bench	Seat width	57	1448	Overall width
Radius = 48"	Seat depth	21	533	Overall depth
Degree = 60°	Seat height	18	457	Overall height

Model	Frame	Upholstery / List (\$)	Tablet finish	Other options (\$)
H4860X	E8 Std	Grade 1 2,564	Specify laminate code	PC (1x) 600
	E9 N/C	Grade 2 2,579		
	E1 320	Grade 3 2,598		
	K8 220	Grade 4 2,617		
	K9 220	Grade 5 2,635		
	K1 495	Grade 6 2,654		
		Grade 8 2,692		

HC4860

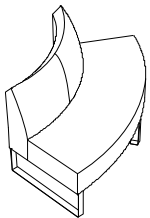

Description	Dimensions (in)	(mm)	Dimensions (in)	(mm)
Wedge chair	Seat width	78	1981	Overall width
Radius = 48"	Seat depth	21	533	Overall depth
Degree = 60°	Seat height	18	457	Overall height
	Back height	16	406	
	Back width	57	1448	

Model	Frame	Upholstery / List (\$)
HC4860	E8 Std	Grade 1 2,977
	E9 N/C	Grade 2 3,005
	E1 320	Grade 3 3,041
	K8 220	Grade 4 3,077
	K9 220	Grade 5 3,112
	K1 495	Grade 6 3,148
		Grade 8 3,219

H4860C

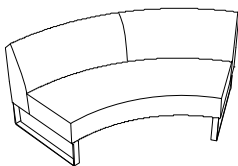

Description	Dimensions (in)	(mm)	Dimensions (in)	(mm)
Wedge chair	Seat width	69 ¼	1759	Overall width
Radius = 48"	Seat depth	21	533	Overall depth
Degree = 60°	Seat height	18	457	Overall height
	Back height	16	406	
	Back width	69 ¼	1759	

Model	Frame	Upholstery / List (\$)
H4860C	E8 Std	Grade 1 2,977
	E9 N/C	Grade 2 3,007
	E1 320	Grade 3 3,044
	K8 220	Grade 4 3,082
	K9 220	Grade 5 3,119
	K1 495	Grade 6 3,157
		Grade 8 3,232

H7830

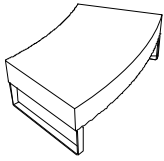

Description	Dimensions	(in)	(mm)	Dimensions	(in)	(mm)
Wedge bench	Seat width	56	1422	Overall width	56	1422
Radius = 78"	Seat depth	30	762	Overall depth	32 ¾	832
Degree = 30°	Seat height	18	457	Overall height	18	457

Model	Frame	Upholstery / List (\$)
H7830	E8 Std	Grade 1 1,745
	E9 N/C	Grade 2 1,760
	E1 225	Grade 3 1,779
	K8 200	Grade 4 1,797
	K9 200	Grade 5 1,816
	K1 400	Grade 6 1,835
		Grade 8 1,872

HX7830

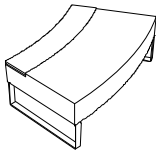

Description	Dimensions	(in)	(mm)	Dimensions	(in)	(mm)
Mixed wedge bench	Seat width	56	1422	Overall width	56	1422
Radius = 78"	Seat depth	21	533	Overall depth	32 ¾	832
Degree = 30°	Seat height	18	457	Overall height	18	457

Model	Frame	Upholstery / List (\$)	Tablet finish	Other options (\$)
HX7830	E8 Std	Grade 1 1,989	Specify laminate code	PC (1x) 600
	E9 N/C	Grade 2 2,004		
	E1 225	Grade 3 2,023		
	K8 200	Grade 4 2,041		
	K9 200	Grade 5 2,060		
	K1 400	Grade 6 2,079		
		Grade 8 2,116		

H7830X

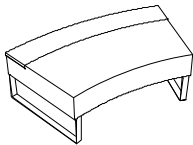

Description	Dimensions	(in)	(mm)	Dimensions	(in)	(mm)
Mixed wedge bench	Seat width	51	1295	Overall width	56	1422
Radius = 78"	Seat depth	21	533	Overall depth	32 ¾	832
Degree = 30°	Seat height	18	457	Overall height	18	457

Model	Frame	Upholstery / List (\$)	Tablet finish	Other options (\$)
H7830X	E8 Std	Grade 1 1,989	Specify laminate code	PC (1x) 600
	E9 N/C	Grade 2 2,004		
	E1 225	Grade 3 2,023		
	K8 200	Grade 4 2,041		
	K9 200	Grade 5 2,060		
	K1 400	Grade 6 2,079		
		Grade 8 2,116		

HC7830

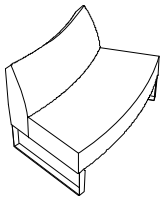

Description	Dimensions	(in)	(mm)	Dimensions	(in)	(mm)
Wedge chair	Seat width	56	1422	Overall width	56	1422
Radius = 78"	Seat depth	21	533	Overall depth	32 ¾	832
Degree = 30°	Seat height	18	457	Overall height	34	864
	Back height	16	406			
	Back width	45	1143			

Model	Frame	Upholstery / List (\$)
HC7830	E8 Std	Grade 1 2,427
	E9 N/C	Grade 2 2,449
	E1 225	Grade 3 2,477
	K8 200	Grade 4 2,505
	K9 200	Grade 5 2,533
	K1 400	Grade 6 2,562
		Grade 8 2,618

H7830C

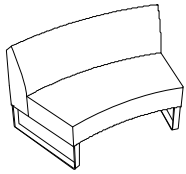

Description	Dimensions	(in)	(mm)	Dimensions	(in)	(mm)
Wedge chair	Seat width	51 ½	1308	Overall width	56	1422
Radius = 78"	Seat depth	21	533	Overall depth	32 ¾	832
Degree = 30°	Seat height	18	457	Overall height	34	864
	Back height	16	406			
	Back width	51 ½	1308			

Model	Frame	Upholstery / List (\$)
H7830C	E8 Std	Grade 1 2,427
	E9 N/C	Grade 2 2,452
	E1 225	Grade 3 2,483
	K8 200	Grade 4 2,514
	K9 200	Grade 5 2,545
	K1 400	Grade 6 2,577
		Grade 8 2,639

H7845

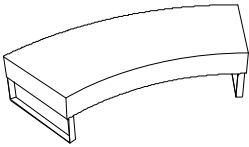

Description	Dimensions	(in)	(mm)	Dimensions	(in)	(mm)
Wedge bench	Seat width	83	2108	Overall width	83	2108
Radius = 78"	Seat depth	30	762	Overall depth	36	915
Degree = 45°	Seat height	18	457	Overall height	18	457

Model	Frame	Upholstery / List (\$)
H7845	E8 Std	Grade 1 2,258
	E9 N/C	Grade 2 2,275
	E1 320	Grade 3 2,297
	K8 220	Grade 4 2,319
	K9 220	Grade 5 2,341
	K1 495	Grade 6 2,363
		Grade 8 2,407

HX7845

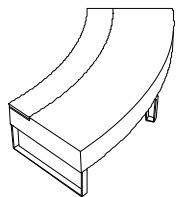

Description	Dimensions	(in)	(mm)	Dimensions	(in)	(mm)
Mixed wedge bench	Seat width	83	2108	Overall width	83	2108
Radius = 78"	Seat depth	21	533	Overall depth	36	915
Degree = 45°	Seat height	18	457	Overall height	18	457

Model	Frame	Upholstery / List (\$)	Tablet finish	Other options (\$)
HX7845	E8 Std	Grade 1 2,614	Specify laminate code	PC (1x) 600
	E9 N/C	Grade 2 2,632		
	E1 320	Grade 3 2,654		
	K8 220	Grade 4 2,675		
	K9 220	Grade 5 2,697		
	K1 495	Grade 6 2,719		
		Grade 8 2,763		

H7845X

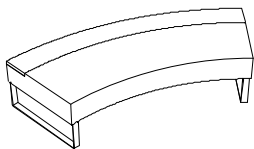

Description	Dimensions	(in)	(mm)	Dimensions	(in)	(mm)
Mixed wedge bench	Seat width	83	2108	Overall width	83	2108
Radius = 78"	Seat depth	21	533	Overall depth	36	915
Degree = 45°	Seat height	18	457	Overall height	18	457

Model	Frame	Upholstery / List (\$)	Tablet finish	Other options (\$)
H7845X	E8 Std	Grade 1 2,614	Specify laminate code	PC (1x) 600
	E9 N/C	Grade 2 2,632		
	E1 320	Grade 3 2,654		
	K8 220	Grade 4 2,675		
	K9 220	Grade 5 2,697		
	K1 495	Grade 6 2,719		
		Grade 8 2,763		

HC7845

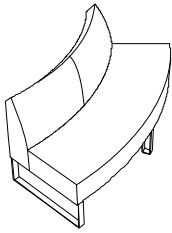

Description	Dimensions	(in)	(mm)	Dimensions	(in)	(mm)
Wedge chair Radius = 78" Degree = 45°	Seat width	83	2108	Overall width	83	2108
	Seat depth	21	533	Overall depth	36	915
	Seat height	18	457	Overall height	34	864
	Back height	16	406			
	Back width	67	1702			

Model	Frame	Upholstery / List (\$)
HC7845	E8 Std	Grade 1 3,208
	E9 N/C	Grade 2 3,243
	E1 320	Grade 3 3,287
	K8 220	Grade 4 3,331
	K9 220	Grade 5 3,375
	K1 495	Grade 6 3,418
		Grade 7 3,462
		Grade 8 3,506

H7845C

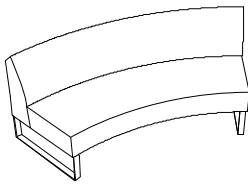

Description	Dimensions	(in)	(mm)	Dimensions	(in)	(mm)
Wedge chair Radius = 78" Degree = 45°	Seat width	76	1930	Overall width	83	2108
	Seat depth	21	533	Overall depth	36	915
	Seat height	18	457	Overall height	34	864
	Back height	16	406			
	Back width	76	1930			

Model	Frame	Upholstery / List (\$)
H7845C	E8 Std	Grade 1 3,208
	E9 N/C	Grade 2 3,243
	E1 320	Grade 3 3,287
	K8 220	Grade 4 3,331
	K9 220	Grade 5 3,375
	K1 495	Grade 6 3,418
		Grade 7 3,462
		Grade 8 3,506

HR24



Description	Dimensions	(in)	(mm)
Round ottoman	Overall width	24	610
	Overall depth	24	610
	Overall height	18	457

Model	Frame	Upholstery / List (\$)
HR24	E8 Std	Grade 1 907
	E9 N/C	Grade 2 915
	E1 225	Grade 3 925
	K8 200	Grade 4 935
	K9 200	Grade 5 945
	K1 400	Grade 6 955
		Grade 7 965
		Grade 8 975

HR36

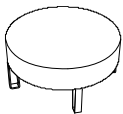

Description	Dimensions	(in)	(mm)
Round ottoman	Overall width	36	914
	Overall depth	36	914
	Overall height	18	457

Model	Frame	Upholstery / List (\$)
HR36	E8 Std	Grade 1 1,163
	E9 N/C	Grade 2 1,176
	E1 225	Grade 3 1,191
	K8 200	Grade 4 1,207
	K9 200	Grade 5 1,223
	K1 400	Grade 6 1,238
		Grade 7 1,254
		Grade 8 1,270

HR48

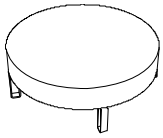

Description	Dimensions	(in)	(mm)
Round ottoman	Overall width	48	1219
	Overall depth	48	1219
	Overall height	18	457

Model	Frame	Upholstery / List (\$)	
HR48	E8 Std	Grade 1	1,614
	E9 N/C	Grade 2	1,631
	E1 225	Grade 3	1,653
	K8 200	Grade 4	1,675
	K9 200	Grade 5	1,697
	K1 400	Grade 6	1,719
		Grade 8	1,762

HRT24



Description	Dimensions	(in)	(mm)
Round table	Seat width	24	610
	Seat depth	24	610
	Seat height	18	457

Model	Frame	Upholstery / List (\$)	Laminate finish	Other options (\$)
HRT24	E8 Std	Grade 1	1,063	Specify code PC (1x) 600
	E9 N/C	Grade 2	1,069	
	E1 225	Grade 3	1,077	
	K8 200	Grade 4	1,084	
	K9 200	Grade 5	1,092	
	K1 400	Grade 6	1,099	
		Grade 8	1,114	

HRT36

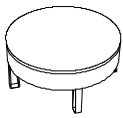

Description	Dimensions	(in)	(mm)
Round table	Seat width	36	915
	Seat depth	36	915
	Seat height	18	457

Model	Frame	Upholstery / List (\$)	Laminate finish	Other options (\$)
HRT36	E8 Std	Grade 1	1,463	Specify code PC (1x) 600
	E9 N/C	Grade 2	1,471	
	E1 225	Grade 3	1,481	
	K8 200	Grade 4	1,491	
	K9 200	Grade 5	1,501	
	K1 400	Grade 6	1,511	
		Grade 8	1,531	

HRT48

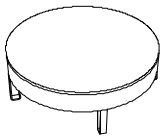

Description	Dimensions	(in)	(mm)
Round table	Overall width	48	1219
	Overall depth	48	1219
	Overall height	18	457

Model	Frame	Upholstery / List (\$)	Laminate finish	Other options (\$)
HRT48	E8 Std	Grade 1	2,033	Specify code PC (1x) 600
	E9 N/C	Grade 2	2,040	
	E1 225	Grade 3	2,048	
	K8 200	Grade 4	2,057	
	K9 200	Grade 5	2,066	
	K1 400	Grade 6	2,075	
		Grade 8	2,092	

HRTM36

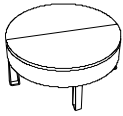

Description	Dimensions	(in)	(mm)
Mixed table ottoman	Seat width	36	915
	Seat depth	36	915
	Seat height	18	457

Model	Frame	Upholstery / List (\$)	Laminate finish	Other options (\$)
HRTM36	E8 Std	Grade 1 1,420	Specify code	PC (1x) 600
	E9 N/C	Grade 2 1,428		
	E1 225	Grade 3 1,439		
	K8 200	Grade 4 1,450		
	K9 200	Grade 5 1,461		
	K1 400	Grade 6 1,472		
		Grade 8 1,494		

H RTP48

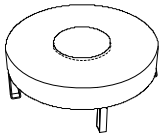

Description	Dimensions	(in)	(mm)
Mixed table ottoman	Overall width	48	1219
	Overall depth	48	1219
	Overall height	18	457

Model	Frame	Upholstery / List (\$)	Laminate finish	Other options (\$)
H RTP48	E8 Std	Grade 1 2,095	Specify code	PC (1x) 600
	E9 N/C	Grade 2 2,113		
	E1 225	Grade 3 2,134		
	K8 200	Grade 4 2,156		
	K9 200	Grade 5 2,178		
	K1 400	Grade 6 2,200		
		Grade 8 2,244		

HOT

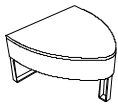

Description	Dimensions	(in)	(mm)
Ogive table	Seat width	30	762
	Seat depth	30	762
	Seat height	18	457

Model	Frame	Upholstery / List (\$)	Laminate finish	Other options (\$)
HOT	E8 Std	Grade 1 1,451	Specify code	PC (1x) 600
	E9 N/C	Grade 2 1,455		
	E1 225	Grade 3 1,461		
	K8 200	Grade 4 1,467		
	K9 200	Grade 5 1,472		
	K1 400	Grade 6 1,478		
		Grade 8 1,489		

HT30

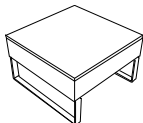

Description	Dimensions	(in)	(mm)
Square table	Seat width	30	762
	Seat depth	30	762
	Seat height	18	457

Model	Frame	Upholstery / List (\$)	Laminate finish	Other options (\$)
HT30	E8 Std	Grade 1 1,207	Specify code	PC (1x) 600
	E9 N/C	Grade 2 1,212		
	E1 225	Grade 3 1,217		
	K8 200	Grade 4 1,223		
	K9 200	Grade 5 1,228		
	K1 400	Grade 6 1,234		
		Grade 8 1,245		

HT60

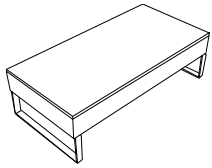

Description	Dimensions	(in)	(mm)
Rectangular table	Seat width	60	1524
	Seat depth	30	762
	Seat height	18	457

Model	Frame	Upholstery / List (\$)	Laminate finish	Other options (\$)
HT60	E8 Std	Grade 1	1,870	Specify code
	E9 N/C	Grade 2	1,881	
	E1 225	Grade 3	1,895	
	K8 200	Grade 4	1,908	
	K9 200	Grade 5	1,922	
	K1 400	Grade 6	1,936	
		Grade 8	1,964	

HA

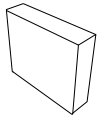

Description	Dimensions	(in)	(mm)
Upholstered arm	Overall width	7 1/2	191
	Overall depth	30	762
	Overall height	30	762

Model	Upholstery / List (\$)	Other options (\$)
HA	Grade 1	457
	Grade 2	464
	Grade 3	473
	Grade 4	483
	Grade 5	492
	Grade 6	502
	Grade 8	520

H-B153030

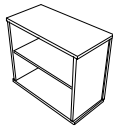

Description	Dimensions	(in)	(mm)
Bookcase	Overall width	15	381
	Overall depth	30	762
	Overall height	30	762

Model	List (\$)	Laminate finish
H-B153030	663	Specify code

HIP HOP JUNIOR

HJ24

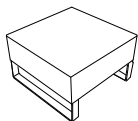

Description	Dimensions	(in)	(mm)
Square bench	Overall width	24	610
	Overall depth	24	610
	Overall height	14	356

Model	Frame	Upholstery / List (\$)
HJ24	E8 Std	Grade 1
	E9 N/C	Grade 2
		Grade 3
		Grade 4
		Grade 5
		Grade 6
		Grade 8

HJC24

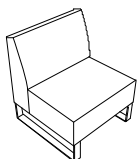

Description	Dimensions	(in)	(mm)	Dimensions	(in)	(mm)
Straight chair	Seat width	24	610	Overall width	24	610
	Seat depth	17	432	Overall depth	24	610
	Seat height	14	356	Overall height	28	711
	Back height	14	356			
	Back width	24	610			

Model	Frame	Upholstery / List (\$)
HJC24	E8 Std	Grade 1
	E9 N/C	Grade 2
		Grade 3
		Grade 4
		Grade 5
		Grade 6
		Grade 8

HJ48

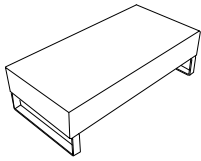

Description	Dimensions	(in)	(mm)
Rectangular bench	Overall width	48	1219
	Overall depth	24	610
	Overall height	14	356

Model	Frame	Upholstery / List (\$)	
HJ48	E8 Std	Grade 1	1,144
		Grade 2	1,154
	E9 N/C	Grade 3	1,167
		Grade 4	1,180
		Grade 5	1,192
		Grade 6	1,205
		Grade 7	1,217
		Grade 8	1,230

HJC48

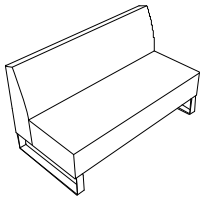

Description	Dimensions	(in)	(mm)	Dimensions	(in)	(mm)
Loveseat	Overall width	48	1219	Seat width	48	1219
	Overall depth	24	610	Seat depth	17	432
	Overall height	28	711	Seat height	14	356
	Back height	14	356			
	Back width	48	1219			

Model	Frame	Upholstery / List (\$)	
HJC48	E8 Std	Grade 1	1,595
		Grade 2	1,607
	E9 N/C	Grade 3	1,623
		Grade 4	1,639
		Grade 5	1,654
		Grade 6	1,670
		Grade 7	1,685
		Grade 8	1,701

HJ2445

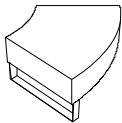

Description	Dimensions	(in)	(mm)	Dimensions	(in)	(mm)
Wedge bench Radius = 24" Degree = 45°	Seat width	41	1041	Overall width	41	1041
	Seat depth	24	610	Overall depth	31 ¾	806
	Seat height	14	356	Overall height	14	356

Model	Frame	Upholstery / List (\$)	
HJ2445	E8 Std	Grade 1	1,119
		Grade 2	1,129
	E9 N/C	Grade 3	1,142
		Grade 4	1,154
		Grade 5	1,167
		Grade 6	1,180
		Grade 7	1,192
		Grade 8	1,205

HJ2445C

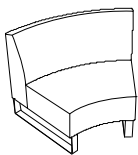

Description	Dimensions	(in)	(mm)	Dimensions	(in)	(mm)
Wedge chair Radius = 24" Degree = 45°	Seat width	32	813	Overall width	37	940
	Seat depth	17	432	Overall depth	26	661
	Seat height	14	356	Overall height	28	711
	Back height	14	356			
	Back width	34 ½	876			

Model	Frame	Upholstery / List (\$)	
HJ2445C	E8 Std	Grade 1	1,395
		Grade 2	1,410
	E9 N/C	Grade 3	1,428
		Grade 4	1,447
		Grade 5	1,466
		Grade 6	1,485
		Grade 7	1,504
		Grade 8	1,522

HJC2445

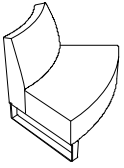

Description	Dimensions (in)	(mm)	Dimensions (in)	(mm)		
Wedge chair	Seat width	32	813	Overall width	37	940
Radius = 24"	Seat depth	17	432	Overall depth	26	661
Degree = 45°	Seat height	14	356	Overall height	28	711
	Back height	14	356			
	Back width	25 1/4	641			

Model	Frame	Upholstery / List (\$)
HJC2445	E8 Std	Grade 1 1,395
		Grade 2 1,410
	E9 N/C	Grade 3 1,428
		Grade 4 1,447
		Grade 5 1,466
		Grade 6 1,485
		Grade 8 1,522

HIP HOP - SOLUTIONS

HOP - S1 **\$58,356**

- 6 HC1860
- 6 HC4860
- 12 HC7830

HOP - S5 **\$9,231**

- 1 H30X
- 1 H60X
- 1 H1860X
- 1 HC1860
- 1 HC4830C

HOP - S2 **\$69,002**

- 4 HO
- 4 HV
- 8 H4830C
- 8 H4860C
- 2 HC4860
- 4 H7830

HOP - S6 **\$13,504**

- 2 HO
- 1 H60
- 2 H4860C
- 1 H RTP48
- 1 H RTM36

HOP - S7 **\$7,098**

- 1 H30X
- 2 H4860C

HOP - S3 **\$18,496**

- 3 HC30
- 2 H4830C
- 2 H4860C
- 2 H7830

HOP - S8 **\$13,020**

- 1 H4830C
- 2 H4860C
- 2 HO
- 1 H RTP48

HOP - S4 **\$8,399**

- 2 HC30
- 1 H4860X
- 1 H4830X
- 1 H RT36

HOP - S9 **\$13,191**

- 1 H60X
- 2 H4860C
- 1 H4860X
- 1 H RTP48